

- Centrale monofase per 1/2 motori 230 Vac
- Cancelli ad ante
- Radio 433 Mhz integrata
- Auto-programmante

Manuale Completo

START-S6XL BLOCK

Versione Radio Integrata

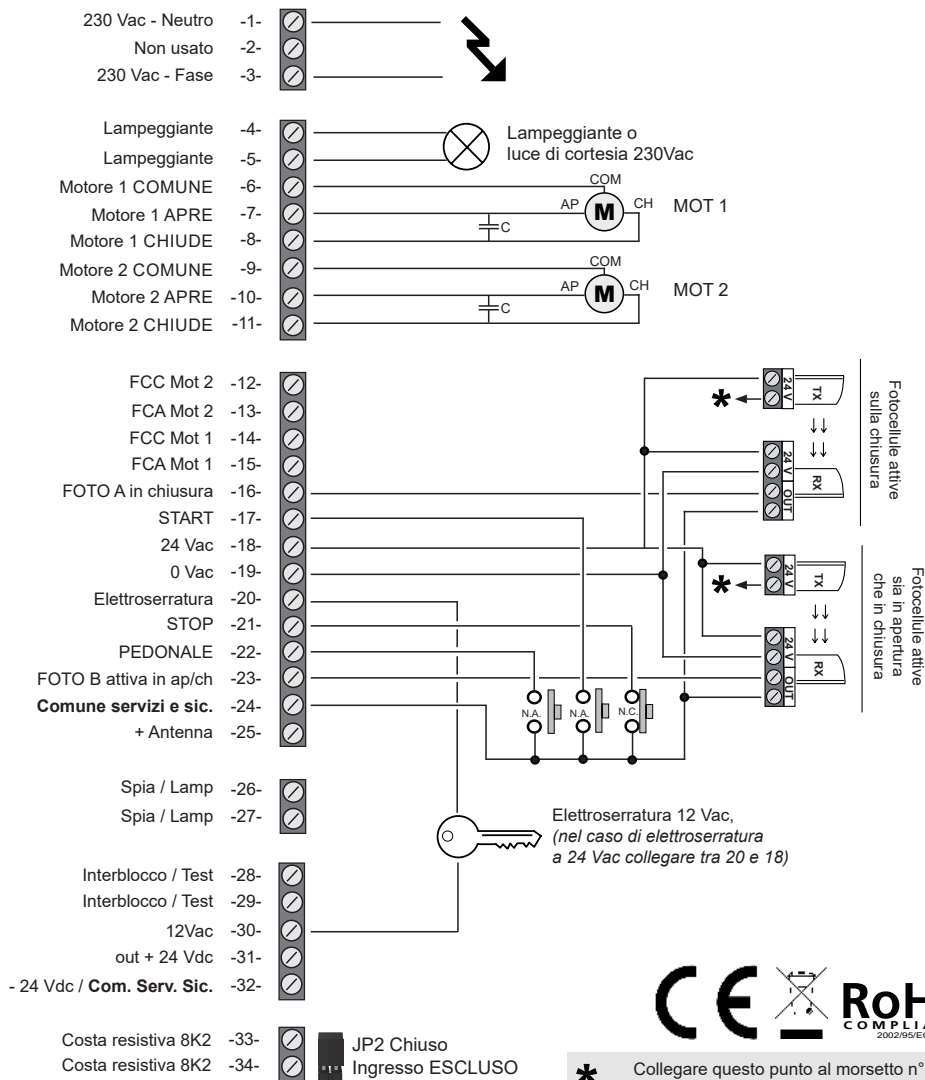

* Collegare questo punto al morsetto n° 28 per avere il test sulle fotocellule. Altrimenti collegarlo al morsetto n° 19

Premessa

Questo manuale fornisce tutte le informazioni specifiche necessarie alla conoscenza ed al corretto utilizzo dell'apparecchiatura in Vostro possesso. Esso deve essere letto attentamente all'atto dell'acquisto dello strumento e consultato ogni volta che sorgano dubbi circa l'utilizzo o ci si accinga ad effettuare interventi di manutenzione. Nologo si riserva il diritto di apportare eventuali modifiche al prodotto senza preavviso.

Precauzioni di sicurezza

In caso di utilizzo scorretto, di riparazioni o modifiche apportate personalmente decade qualsiasi garanzia. Nologo declina ogni responsabilità per i danni derivanti da un utilizzo non appropriato del prodotto o da utilizzo diverso da quello per cui il prodotto è stato creato. Nologo declina ogni responsabilità per danni consequenziali ad eccezione della responsabilità civile sui prodotti.

L'automazione deve essere realizzata in conformità alle vigenti normative europee: **EN 60204-1**, **EN 12445**, **EN 12453**. E' obbligo attenersi alle norme per chiusure veicolari automatizzate: **EN 12453**, **EN 12445**, **EN 12978** ed alle eventuali prescrizioni nazionali. La regolazione della forza di spinta dell'anta deve essere misurata con apposito strumento e regolata in accordo ai valori massimi ammessi dalla normativa **EN 12453**.

Misure di tutela dell'ambiente

Informazioni relative all'ambiente per i clienti residenti nell'Unione Europea. La direttiva europea 2002/96/EC richiede che le apparecchiature contrassegnate con questo simbolo sul prodotto e/o sull'imballaggio non siano smaltite insieme ai rifiuti urbani non differenziati.



Il simbolo indica che questo prodotto non deve essere smaltito insieme ai normali rifiuti domestici. È responsabilità del proprietario smaltire sia questi prodotti sia le altre apparecchiature elettriche ed elettroniche mediante le specifiche strutture di raccolta indicate dal governo o dagli enti pubblici locali. Il corretto smaltimento ed il riciclaggio aiuteranno a prevenire conseguenze potenzialmente negative per l'ambiente e per la salute dell'essere umano. Per ricevere informazioni più dettagliate circa lo smaltimento delle vecchie apparecchiature in Vostro possesso, Vi invitiamo a contattare gli enti pubblici di competenza, il servizio di smaltimento rifiuti o il negozio nel quale avete acquistato il prodotto.

Piccola legenda

FCA	Fine corsa apre
FCC	Fine corsa chiude
START	comando per azionare il movimento del cancello
PEDONALE	nello scorrevole: comando apertura parziale
Vac	(alternate current) corrente alternata
Vdc	(direct current) corrente continua
NC	normalmente chiuso
NA / NO	normalmente aperto
Contatto pulito	isolato dalle tensioni di alimentazione

Indice capitoli

Par.	Descrizione	Pag.
2	Descrizione prodotto	4
2.1	Caratteristiche funzionali	
2.2	Campi di applicazione	
2.3	Caratteristiche tecniche	
3	Premesse	5
3.1	Verifiche preliminari	
3.2	Tipologia dei cavi elettrici	
3.3	Note sui collegamenti	
4	Installazione della Centrale	6
4.1	Schema e collegamenti elettrici	
4.2	Collegamento della TENSIONE di RETE	7
4.3	Collegamento MOTORE	
4.4	Collegamento del LAMPEGGIANTE	
4.5	Collegamento di una SPIA 24Vdc	
4.6	Collegamento LUCE di CORTESIA	8
4.7	Collegamento ANTENNA	
4.8	Collegamento dispositivi di arresto comando STOP	
4.9	Collegamento dei FINECORSO FCA e FCC	
4.10	Collegamento dei comandi di START e PEDONALE	9
4.11	Collegamento SERRATURA 12 o 24 Vac	
4.12	Alimentazione ACCESSORI	
4.13	Collegamento delle FOTOCELLULE A	10
4.14	Collegamento delle FOTOCELLULE A con TEST	
4.15	Collegamento delle FOTOCELLULE B	11
4.16	Collegamento delle FOTOCELLULE B con TEST	
4.17	Verifica dei collegamenti	12
5	Modi di funzionamento e regolazioni	12
5.1	Impostazione dei comandi DIP B	
5.2	Impostazione dei comandi DIP A	14
5.3	Impostazioni AGGIUNTIVE	15
6	Gestione telecomandi	16
6.1	CANCELLAZIONE completa della memoria codici	
6.2	Gestione Rolling	
6.3	APPRENDIMENTO del telecomando	16
8	Reset della memoria tempi della centrale	
8	Apprendimento TEMPI	17
8.1	apprendimento tempi NORMALE	
8.2	apprendimento tempi AVANZATO	18
8.3	apprendimento tempi APERTURA PEDONALE	19
8.4	Apprendimento veloce TEMPO DI PAUSA	20
9	Istruzioni per l'utilizzo dei TEST	
10	Regolazione TRIMMER	21
11	Note	
11	Dichiarazione CE di conformità	23

1 Introduzione

1.1 Precauzioni di sicurezza

In caso di utilizzo scorretto, di riparazioni o modifiche apportate personalmente decade qualsiasi garanzia. Il produttore declina ogni responsabilità per i danni derivanti da un utilizzo non appropriato del prodotto o da utilizzo diverso da quello per cui il prodotto è stato creato. Il produttore declina ogni responsabilità per danni consequenziali ad eccezione della responsabilità civile sui prodotti.

1.2 Simbologia e avvertenze



Pericolo Generico

Si identifica un'avvertenza di sicurezza la cui inosservanza può provocare danni materiali!



Leggere attentamente il manuale

Leggere attentamente questo manuale prima di utilizzare il prodotto e conservare il manuale per futuro riferimento.



Apparecchiatura sotto tensione

Installazione solo da parte di personale qualificato.

1.3 Sistemi di sicurezza

Sarà importante una approfondita analisi dei rischi della “MACCHINA” e delle richieste dell'utilizzatore finale per stabilire il numero di elementi da installare. Nello schema la coppia di fotocellule “Foto A” in apertura non ha effetto, mentre provoca una inversione totale durante la chiusura. La “Foto A2” è il collegamento in serie della “Foto A” oppure un collegamento a “ALT”. Verificare che le fotocellule dispongano del sistema di sincronismo, permettendo così di eliminare il problema dell'interferenza tra due coppie di fotocellule

Applicazione su automazione ad ante

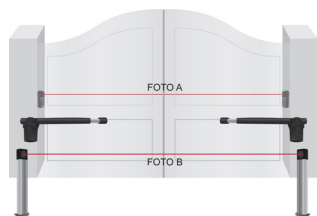

Applicazione su automazione scorrevole

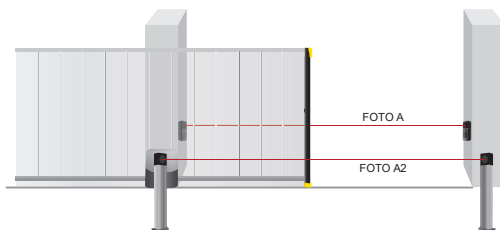

Per una maggiore sicurezza è consigliabile installare un interruttore di STOP che quando azionato provoca il blocco immediato dell'automazione. L'interruttore deve avere un contatto normalmente chiuso, che si apre in caso di azionamento. Come indicato nel Par. 4.8

2 Descrizione Prodotto

La START-S6XL BLOCK è stata realizzata per soddisfare molteplici esigenze: per cancelli ad anta e cancelli scorrevoli. Nel progetto sono state adottate le più avanzate tecniche per garantire la massima immunità nei confronti dei disturbi, la migliore flessibilità d'uso e la più vasta scelta di funzioni disponibili.

2.1 Caratteristiche funzionali

☞	Regolazione velocità di rallentamento
☞	Autoapprendimento dei tempi di lavoro
☞	Regolazione elettronica della forza motore
☞	4 modi di funzionamento (condominiale incluso)
☞	Impostazione delle funzioni tramite dip
☞	Contatto libero per spia cancello aperto
☞	Radio integrata in grado di gestire anche codici rolling
☞	Dimensioni ridotte
☞	Anta pedonale (apertura parziale) con comando separato
☞	Elettroserratura e colpo d'ariete
☞	Dip esclusione di tutti gli ingressi di sicurezza
☞	Funzione TEST compatibile con TRANSCEIVER

2.2 Campi di applicazione

La centrale elettronica START-S6XL BLOCK è utilizzabile per comandare il movimento di cancelli, portoni basculanti, serrande e porte automatiche. Può essere collegata ad un attuatore oleodinamico o elettromeccanico dotato di motore asincrono monofase, funzionanti con tensione di 230 Vac.

2.3 Campi di applicazione

Dimensioni	150 x 135 x 50	mm
Peso	500	g
Potenza singolo motore MAX	1 750 4	HP W A
Potenza lampeggiante MAX	40	W
Assorbimento MAX contatto pulito	2	A
Assorbimento MAX 24 Vac (mors. 18-19)	300	mA
Assorbimento MAX 12 Vac (mors. 19-30)	600	mA
Assorbimento MAX 24 Vdc (mors. 31-32)	100	mA

3 Premesse

3.1 Verifiche preliminari

E' fondamentale fare una scelta corretta nell'installazione della centrale per una adeguata sicurezza e una buona protezione agli agenti atmosferici. Ricordiamo che la centrale contiene parti sottoposte a tensione di rete e componenti elettronici che per loro stessa natura sono sensibili alle infiltrazioni e all'umidità. La centrale viene fornita in un contenitore che se adeguatamente installato garantisce un grado di protezione IP55. Installare la centrale su una superficie irremovibile, perfettamente piana ed adeguatamente protetta da urti, almeno 40 cm dal terreno. I cavi devono entrare nella centrale solo dal lato inferiore, si raccomandano pressacavi e raccordi stagni. Nel caso si usino tubazioni soggette a riempirsi d'acqua o se queste tubazioni provengono da un pozzetto interrato è necessario far entrare i cavi in una prima scatola di derivazione posta alla stessa altezza della centrale e poi da questa, sempre dal lato inferiore, passare i cavi dentro il contenitore della centrale. In questo modo si evita che un eventuale processo di evaporazione dell'acqua nelle tubazioni possa formare condensa dentro la centrale stessa.

3.2 Tipologia dei cavi elettrici

A seconda dell'installazione, del tipo e della quantità di dispositivi installati, i cavi necessari possono variare; nella tabella seguente sono rappresentati i cavi necessari per una installazione tipica.

I cavi utilizzati nell'installazione devono essere conformi alla norma IEC 60335.

⇒	Linea elettrica di alimentazione	Cavo 3x1,5 mm ²
⇒	Cavo motore (se non provvisto)	Cavo 4 x 1,5 mm ²
⇒	Segnalatore lampeggiante	Cavo 2x1,5 mm ²
⇒	Antenna radio	Cavo schermato tipo RG58
⇒	Selettore	Cavo 3x0,5 o 0,75 mm ²
⇒	Foto Rx	Cavo 4x0,5 o 0,75 mm ²
⇒	Foto Tx	Cavo 2x0,5 o 0,75 mm ²

3.3 Note sui collegamenti

Per garantire l'incolumità dell'operatore e per prevenire danni ai componenti, mentre si effettuano i collegamenti o si innesta la scheda radio ricevente, la centrale deve essere assolutamente non alimentata.

- Alimentare la centrale attraverso un cavo da 3 x 1,5mm². Se la distanza fra la centrale e la connessione all'impianto di terra supera i 30m è necessario prevedere un dispersore di terra in prossimità della centrale.
- Se i motori sono sprovvisti di cavo usare il tipo 4 x 1,5 mm² (apre + chiude + comune + terra)
- Nei collegamenti a bassissima tensione di sicurezza usare cavi di sezione minima pari a 0,5 o 0,75mm².
- Usare cavetti schermati se la lunghezza supera i 30m collegando la calza a terra solo dal lato della centrale.
- Evitare di fare connessioni ai cavi in casse interrate anche se completamente stagne.
- Gli ingressi dei contatti di tipo Normalmente Chiuso (NC), se non usati, vanno ponticellati con "comune".
- Se per lo stesso ingresso ci sono più contatti (NC) vanno posti in serie tra di loro.
- Gli ingressi dei contatti di tipo Normalmente Aperto (NA) se non usati vanno lasciati liberi.
- Se per lo stesso ingresso ci sono più contatti (NA) vanno posti in parallelo tra di loro.
- I contatti devono essere assolutamente di tipo meccanico e svincolati da qualsiasi potenziale.

Ricordiamo che gli impianti di cancelli e porte automatiche devono essere installati solo da personale tecnico qualificato e nel pieno rispetto delle norme di legge.

4 Installazione della centrale

4.1 Schema e collegamenti elettrici

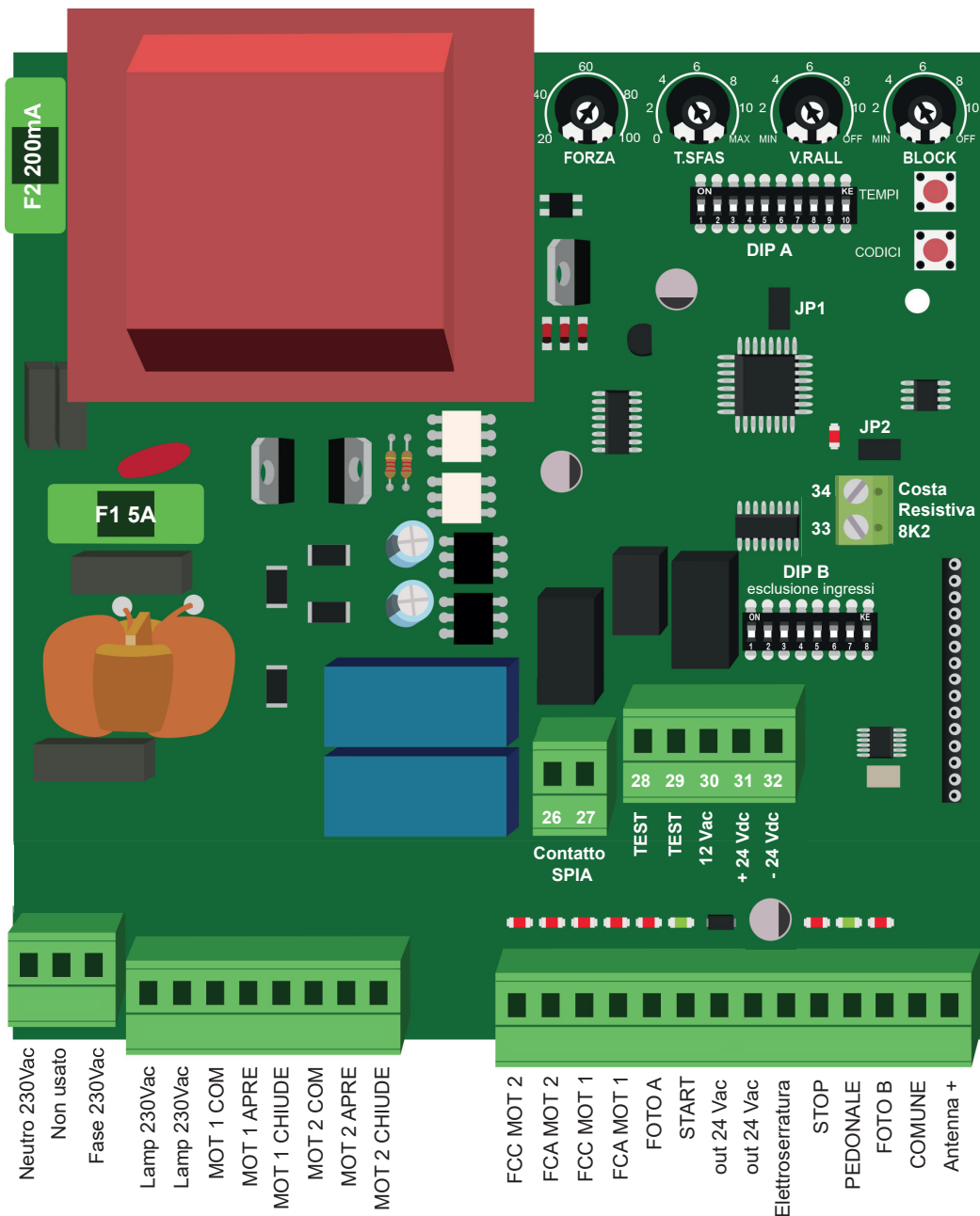

230 Vac Neutro	1		Alimentazione elettrica 230 Vac 50 Hz NEUTRO
Terra	2		TERRA
230 Vac Fase	3		Alimentazione elettrica 230 Vac 50 Hz FASE
Lampeggiante	4		Uscite per LAMPEGGIANTE (con scheda elettronica di intermittenza) o LUCE di CORTESIA 230Vac, potenza massima della lampada 40 o 100W.
	5		
M 1 Com	6		Uscita per collegamento motore 1 polo COMUNE
M 1 Apre	7		Uscita per collegamento motore 1 polo APRE
M 1 Chiude	8		Uscita per collegamento motore 1 polo CHIUDE
M 2 Com	9		Uscita per collegamento motore 2 polo COMUNE
M 2 Apre	10		Uscita per collegamento motore 2 polo APRE
M 2 Chiude	11		Uscita per collegamento motore 2 polo CHIUDE
FCC M2	12		Ingresso Fine Corsa Chiude del motore 2
FCA M2	13		Ingresso Fine Corsa Apre del motore 2
FCC M1	14		Ingresso Fine Corsa Chiude del motore 1
FCA M1	15		Ingresso Fine Corsa Apre del motore 1
Fotocellula A	16		Ingresso Fotocellula A attiva solo in chiusura
START	17		Ingresso comando passo-passo START
24Vac	18		Uscita 24Vac
24Vac	19		Uscita 24Vac
12Vac Serrat.	20		Uscita per elettroserratura 12Vac 50Hz 1A
STOP	21		Ingresso STOP
PEDONALE	22		Ingresso comando passo-passo apertura parziale PEDONALE
Fotocellula B	23		Ingresso Fotocellula B attiva sia in Chiusura che in Apertura
Comune 1 -	24		Comune per tutti gli ingressi: servizi, sicurezze, calza del cavo, coassiale antenna
Antenna +	25		Ingresso per il segnale antenna (capo caldo filo antenna)
SPIA o Lamp.	26		Contatto per SPIA (per lampeggianti senza scheda elettronica)
SPIA o Lamp.	27		Contatto per SPIA (per lampeggianti senza scheda elettronica)
Interblocco/Test	28		Interblocco / Test
Interblocco/Test	29		Interblocco / Test
12Vac Serrat.	30		Uscita 12Vac
24Vdc +	31		Uscita 24Vdc +
Comune 24Vdc -	32		Uscita 24Vdc - Comune per gli ingressi: servizi, sicurezze.
Costa 8K2	33		Costa Resitiva 8K2 (JP2 chiuso per disabilitare l'ingresso)
Costa 8K2	34		

4.2 Collegamento della TENSIONE di RETE

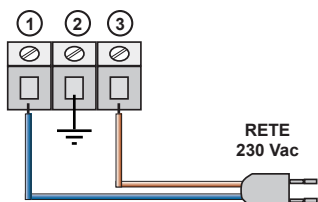

230 Vac. La linea di alimentazione verso la centrale deve essere sempre protetta da interruttore magnetotermico oppure coppia di fusibili da 5A.

Un interruttore differenziale è consigliato ma non indispensabile se è già presente a monte dell'impianto.

4.3 Collegamento MOTORE

Fare particolare attenzione a non invertire i poli APRE e CHIUDE.

In caso si abbiano dei dubbi sul loro corretto collegamento, posizionare manualmente, se possibile, l'automazione a metà della sua corsa. Tenersi pronti a fermare l'impianto mediante un comando di STOP!

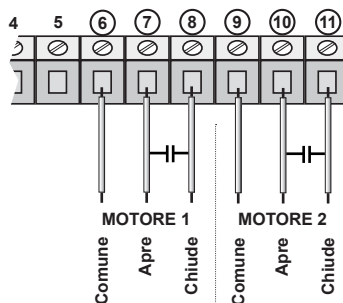

4.4 Collegamento del LAMPEGGIANTE

Lampeggiante completo
di scheda intermittenza

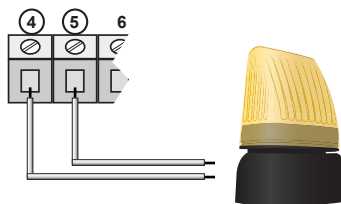

Lampeggiante senza
scheda intermittenza

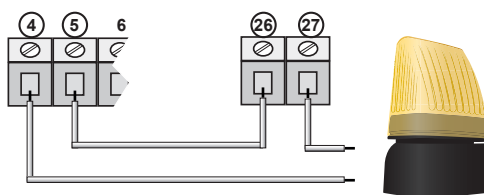

! Se si prevede di utilizzare il test sulle fotocellule, oppure per una spia 24V, non si può utilizzare questo collegamento.

4.5 Collegamento di una SPIA 24Vdc cancello aperto e in movimento

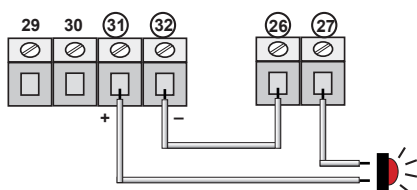

! Se si prevede di utilizzare il test sulle fotocellule, oppure per un lampeggiante, non si può utilizzare questo collegamento.

! Per passare da spia fissa o lampeggiante, occorre semplicemente tenere premuto il pulsante TEMPI, durante la manovra di chiusura, fino a quando il Led non lampeggia.

4.6 Collegamento LUCE CORTESIA

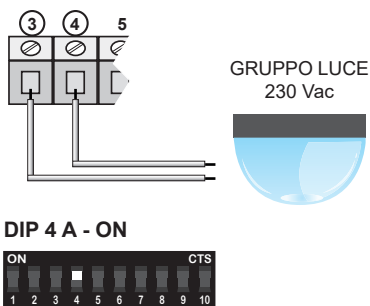

4.7 Collegamento ANTENNA

Se al posto di una antenna si utilizza uno spezzone di filo rigido, per la frequenza 433 Mhz si dovrà tagliarlo a 17 cm e collegarlo solo al morsetto 25.

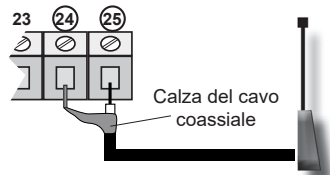

COLLEGARE L'ANTENNA SOLO DOPO AVER EFFETTUATO L'APPRENDIMENTO DEI CODICI DEI RADIOCOMANDI!!!

4.8 Collegamento dispositivi di arresto comando STOP

Collegamento del comando **STOP**

Pulsante: arresta ed inibisce momentaneamente fino a nuovo comando il funzionamento della centrale.

Interruttore: mantiene l'automazione bloccata fino a nuovo ripristino dello stesso.

! Se l'ingresso **STOP** NON viene utilizzato porre in ON il DIP 6 B

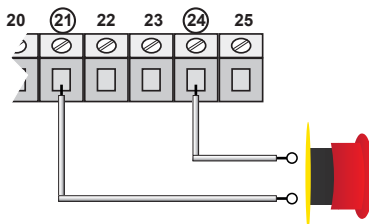

Il collegamento dei dispositivi di sicurezza prevede l'utilizzo di qualsiasi pulsante o contatto di tipo N.C. (normalmente chiuso). Più dispositivi di sicurezza vanno collegati in serie.

4.9 Collegamento dei FINECORSA FCA e FCC

Nella figura viene mostrato il collegamento di entrambe i finecorsa.

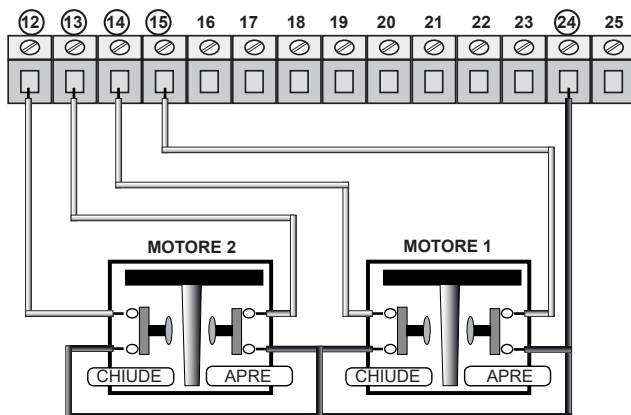

! Se gli ingressi FCA o FCC non vengono utilizzati, seguire quanto riportato nel Paragrafo 5.1

I contatti dei finecorsa devono essere di tipo N.C. (normalmente chiuso)

4.10 Collegamento dei comandi di "START" e "PEDONALE"

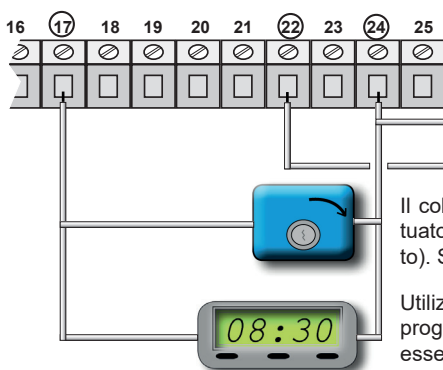

Il collegamento del comando di apertura PEDONALE può essere effettuato su qualsiasi pulsante o contatto di tipo N.A. (normalmente aperto).

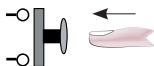

Il collegamento del comando di apertura START può essere effettuato a qualsiasi pulsante o contatto di tipo N.A. (normalmente aperto). Se vi sono più dispositivi, vanno collegati in parallelo.

Utilizzando i morsetti 17 e 24 è possibile collegare un TIMER per programmare delle aperture del cancello. Il contatto del timer deve essere di tipo NA e deve restare in condizione di chiuso per tutto il tempo che il cancello rimane aperto. Se è presente il collegamento del comando di apertura sul morsetto 17, collegare in parallelo.

4.11 Collegamento SERRATURA

Viene ora presentato lo schema di collegamento della serratura 12 Vac:

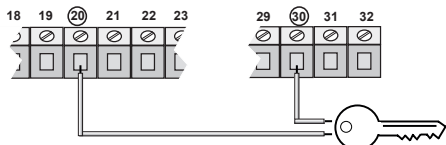

Viene ora presentato lo schema di collegamento della serratura 24 Vac:

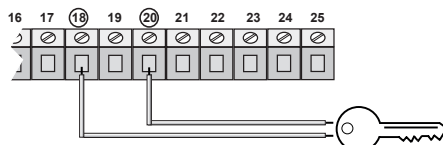

4.12 Alimentazione ACCESSORI

Viene ora presentato lo schema di collegamento per una corretta alimentazione degli accessori, si sottolinea che il valore di tensione 12 Vac è presente tra i morsetti 20-30.

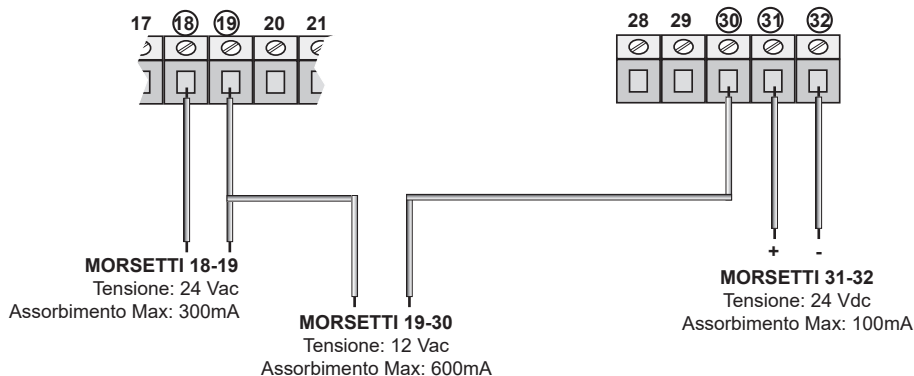

4.13 Collegamento delle FOTOCELLULE A (solo in chiusura) 24 Vac

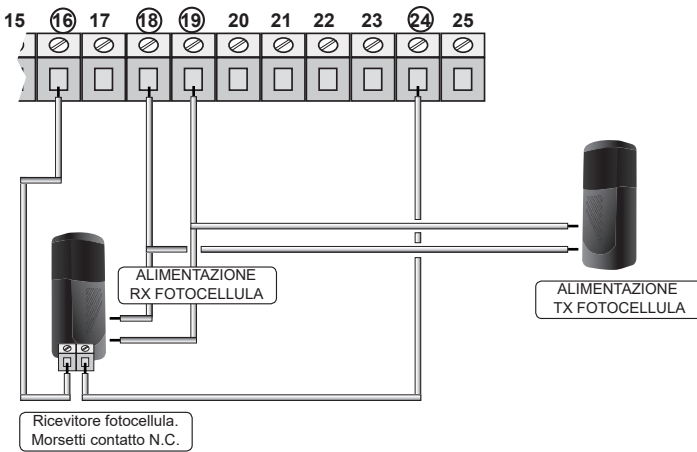

Il contatto del ricevitore della fotocellula deve essere:

- **pulito** (isolato dalle tensioni di alimentazione)
- **tipo N.C.** (normalmente chiuso).

Se si utilizzano più coppie di fotocellule il collegamento deve essere in serie.

! Se l'ingresso FOTO A non viene utilizzato, porre in ON il DIP 5 B

4.14 Collegamento delle FOTOCELLULE A con FOTOTEST 24 Vac

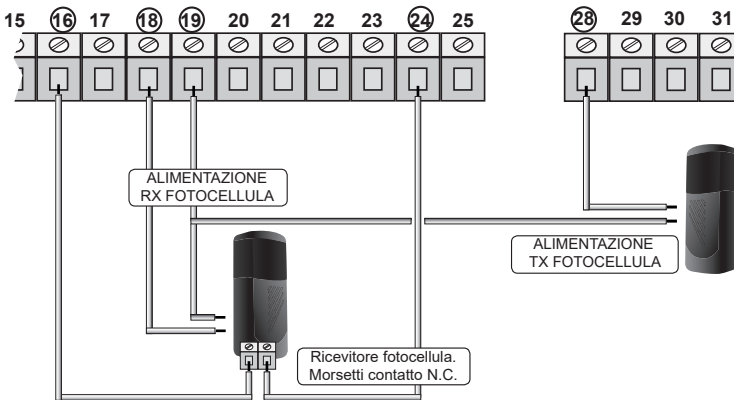

Il contatto del ricevitore della fotocellula deve essere:

- **pulito** (isolato dalle tensioni di alimentazione)
- **tipo N.C.** (normalmente chiuso).

Il TEST sulle fotocellule assicura il funzionamento dell'automazione solo se le fotocellule funzionano regolarmente. La centrale infatti eseguirà il test prima di ogni apertura. In caso di malfunzionamento delle fotocellule, la centrale accenderà per 5 secondi il lampeggiante e non farà partire l'automazione.

Per attivare le funzioni TEST leggere e seguire attentamente quanto riportato nel Capitolo 9

4.15 Collegamento delle FOTOCELLULE B (apertura e chiusura) 24 Vac

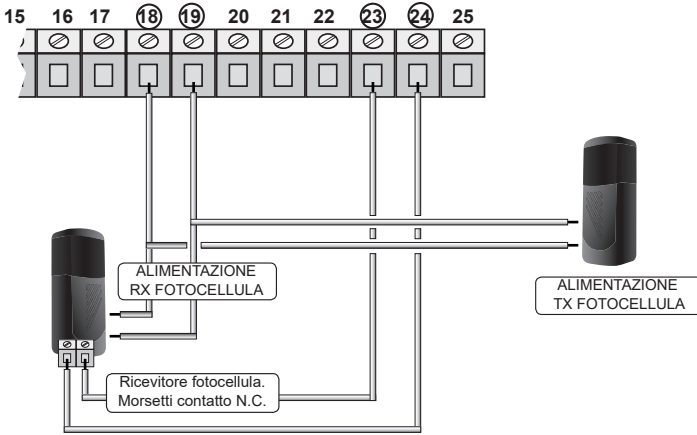

Il contatto del ricevitore della fotocellula deve essere:

- **pulito** (isolato dalle tensioni di alimentazione)
- **tipo N.C.** (normalmente chiuso).

Se si utilizzano più coppie di fotocellule il collegamento deve essere in serie.



Se l'ingresso FOTO B non viene utilizzato, porre in ON il DIP 6 B

4.16 Collegamento delle FOTOCELLULE B con FOTOTEST 24 Vac

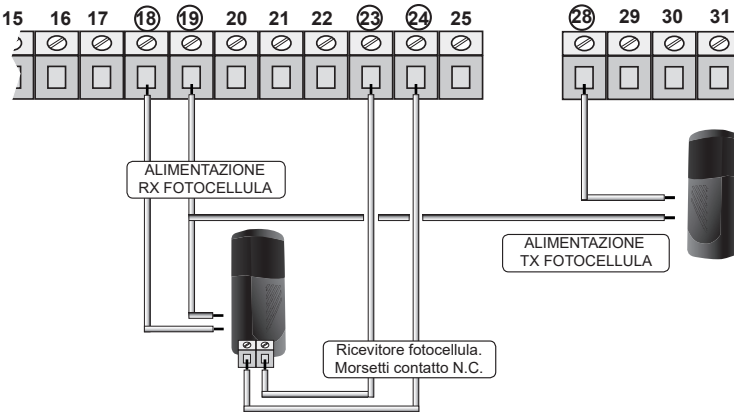

Il contatto del ricevitore della fotocellula deve essere:

- **pulito** (isolato dalle tensioni di alimentazione)
- **tipo N.C.** (normalmente chiuso).

4.17 Verifica dei collegamenti e led di segnalazione

Una volta effettuati tutti i collegamenti e aver escluso tramite il DIP-B tutti gli ingressi non utilizzati, alimentare la centrale e fare attenzione che risultino accessi tutti i led rossi indicati:

(Nel caso i led rossi non risultino tutti accessi, verificare i collegamenti)

Normalmente i **led rossi** sugli ingressi **FCA - FCC - STOP - FOTO** sono **sempre accesi**.

Normalmente i **led verdi** sugli ingressi di comando **START - PEDONALE** sono **normalmente spenti**.

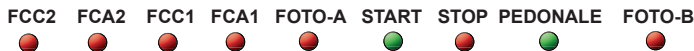

Se durante il lampeggio del led L1, tale led non si spegne completamente significa che l'ingresso **COSTA 8K2** è nella condizione di riposo oppure è stato escluso.







Visualizziamo ora i led che indicano lo stato dell'automazione:

- LED L1**
- Il lampeggio singolo indica il normale funzionamento.
 - Il lampeggio doppio indica il normale funzionamento con rolling completo attivo.
 - Nessun lampeggio indica che JP1 è chiuso e quindi si è nella modalità avanzata.







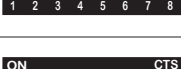





5 Modi di funzionamento e regolazioni

La centrale dispone di una serie di microinterruttori che permettono di attivare varie funzioni al fine di rendere l'impianto più adatto alle esigenze dell'utilizzatore e per la sua maggior sicurezza.

5.1 Impostazione funzioni DIP B



	1-ON	FCC M2 12	Esclusione ingresso finecorsa chiude motore 2
	2-ON	FCA M2 13	Esclusione ingresso finecorsa apre motore 2
	3-ON	FCC M1 14	Esclusione ingresso finecorsa chiude motore 1
	4-ON	FCA M1 15	Esclusione ingresso finecorsa apre motore 1
	5-ON	Fotocellula A 16	Esclusione ingresso fotocellula attiva in chiusura
	6-ON	Fotocellula B 23	Esclusione ingresso fotocellula sempre attiva
	7-ON	STOP 21	Esclusione ingresso stop
	8-ON	Radio Integrata	Viene abilitata la radio integrata

5.2 Impostazione dei comandi DIP A

	1-OFF 2-OFF	Automatico 1	Ad ogni comando inverte: apre - chiude . Richiude automaticamente al termine del tempo di pausa.
	1-ON 2-OFF	Condominiale	In apertura ed in pausa non accetta comandi. Richiude automaticamente al termine del tempo di pausa.
	1-OFF 2-ON	Semi automatico	Ad ogni comando segue la logica apre-stop-chiude-stop-apre ecc.. Non richiude automaticamente.
	1-ON 2-ON	Automatico 2	Ad ogni comando segue la logica apre-stop-chiude-stop-apre ecc.. Richiude automaticamente al termine del tempo di pausa.
	3-ON	Colpo d'ariete	Questa impostazione permette di attivare una spinta in chiusura sia all'inizio che alla fine della manovra per facilitare il funzionamento della elettroserratura se installata.
	4-ON	Luce di cortesia	Nell'uscita dei morsetti 4 e 5 c'è tensione dall'inizio dell'apertura fino a 2 minuti dopo la chiusura, utile quindi per alimentare la luce di cortesia.
	5-ON	Prelampeggio	Attiva il prelampeggio prima di ogni inizio manovra.
	6-ON	Rileva passaggio	Al passaggio rilevato dalle fotocellule, la centrale esegue la completa apertura, poi chiude accorciando ad 1 secondo il tempo di pausa, ad ostacolo liberato.
	7-ON	Lampeggiante in pausa	Il segnalatore luminoso rimane attivo anche nel tempo di pausa
	8-ON	Fototest	Attivazione fototest (In presenza di TRANSCEIVER vedi Cap.9)
	9-ON	Sfasamento in apertura	Posto in ON fissa il tempo di sfasamento in apertura a 2 secondi. Il tempo di sfasamento in chiusura rimane quello impostato con il trimmer "Sfasamento".
	10-ON	Tempi avanzato	Attiva la funzione di apprendimento tempi avanzato

5.3 Impostazioni AGGIUNTIVE

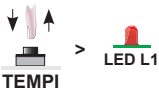
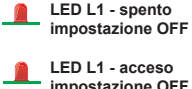
Per accedere alle modalità di funzionamento AGGIUNTIVE, seguire i passaggi riportati:

	1	Assicurarsi che l' automazione sia in posizione di chiuso e che il JUMPER JP1 sia chiuso
	2	Il LED L1 smette di lampeggiare, ora ad ogni pressione del pulsante TEMPI il LED L1 emetterà un numero di lampeggi che indicano a quale impostazione si sta scegliendo.
1 lampeggio	1 motore	Funzionamento ad un motore. La centrale effettua tutte le manovre facendo funzionare il motore 2 in sincrono con il motore 1. L'apprendimento tempi viene effettuato per il solo motore 1.
2 lampeggi	Uomo presente	Questa impostazione permette di attivare il funzionamento a Uomo Presente , il comando START apre il comando PEDONALE chiude. I motori si arrestano appena viene rilasciato il comando.
3 lampeggi	Industriale	Il comando PEDONALE diventa chiude mentre il comando START segue la logica impostata dai dip 1 e 2.
4 lampeggi	Partenza graduale controllata	I motori partono con dei valori di forza minimi fino ad arrivare ai valori impostati. L'utilizzo di questa funzione non e' compatibile con tutte le automazioni, valutarne il suo utilizzo in base all'impianto.
	3	Dopo che il LED L1 ha lampeggiato il n° di volte relativo all'impostazione, il LED rimarrà spento se la funzione scelta è OFF oppure rimarrà acceso se l'impostazione è ON.
	4	Per commutare da OFF a ON e viceversa , premere e rilasciare il pulsante CODICI
	5	Per tornare al NORMALE funzionamento, sistemare il JUMPER JP1 nella posizione di APERTO .



6 Gestione TELECOMANDI

La scheda elettronica è in grado di gestire diversi tipi di codice, il primo telecomando appreso ne determinerà il tipo, di conseguenza, non si possono apprendere telecomandi con tipo di codice differente dal primo telecomando appreso. I codici gestibili sono gli standard da 12 a 64 bit e per i codici rolling tipo HCS© solo la parte fissa, ma attivando seguendo il par. 6.2 si avrà il controllo del contatore rolling. In questo modo i radiocomandi non saranno duplicabili. La capacità con i codici rolling è di n° 200 codici diversi. Il primo trasmettitore appreso determina il tipo di codice che la ricevente deve gestire, di conseguenza i trasmettitori successivamente appresi devono avere lo stesso tipo di codice.

6.1 CANCELLAZIONE completa della memoria codici

Questa operazione cancella tutti i codici presenti in memoria. Non è prevista la cancellazione di un singolo codice. E' necessario eseguire il reset della memoria prima di apprendere il primo telecomando in modo che non ci siano dei codici precedentemente appresi e non utilizzati sull'impianto.

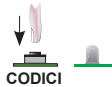
La cancellazione della memoria e quindi di tutti i codici, è possibile ad automazione chiusa.

	1	Assicurarsi che l'automazione sia in posizione di CHIUSO . Premere e tenere premuto il pulsante codici.
	2	Attendere fino a che il LED CODICI lampeggia, poi rilasciare. Attendere la fine del reset della memoria.



6.2 ATTIVAZIONE/DISATTIVAZIONE rolling completo

Modalità codice fisso (L1 - un lampeggio):

I codici gestibili sono gli standard da 12 a 64 bit e per i codici rolling tipo HCS© solo la parte fissa.



Modalità rolling completa (L1 - 2 lampeggi):



Si avrà il controllo del contatore rolling, in questo modo i radiocomandi non saranno duplicabili.

	1	Premere e rilasciare il pulsante codici, il LED L1 rimane acceso fisso
	2	Ripremere ancora il pulsante codici e il LED L1 lampeggia e rimane acceso
	3	Ripremere ancora il pulsante codici e il LED L1 inizierà ad emettere 2 lampeggi, attivazione funzionamento rolling completo effettuata.
	4	Per tornare alla modalità codice fisso, ripetere l'operazione dal punto 1, in questo modo il LED L1 tornerà ad emettere 1 lampeggio.

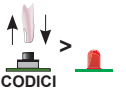
6.3 APPRENDIMENTO del telecomando

L'apprendimento del codice di un telecomando è possibile solo ad automazione in posizione di **CHIUSO**.
SCOLLEGARE L'ANTENNA OGNI VOLTA CHE SI EFFETTUA L'APPRENDIMENTO CODICI!

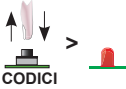
	1	Assicurarsi che l'automazione sia in posizione di CHIUSO
	2	Premere e rilasciare il pulsante codici, il LED L1 rimane acceso fisso.
	3	Premere il tasto del radiocomando es.: 1°, se appreso il LED L1 lampeggerà.

	1	Premere e rilasciare il pulsante codici, il LED L1 rimane acceso fisso
	2	Ripremere ancora il pulsante codici e il LED L1 lampeggia e rimane acceso
	3	Premere il tasto del radiocomando es.: 2°, se appreso il LED L1 lampeggerà.

- Se si desidera apprendere un nuovo radiocomando ripetere semplicemente le operazioni.
- Se alla pressione del tasto del radiocomando il LED L1 rimane acceso, significa che il radiocomando è **INCOMPATIBILE**.
- Se alla pressione del tasto del radiocomando il LED L1 lampeggia lentamente, significa che la memoria codici è **PIENA**.
- In questa scheda non è prevista la cancellazione di un singolo codice radiocomando.









7 Reset della memoria tempi della centrale

Il reset della centrale reimposta i tempi di funzionamento originali della centrale. Il reset della memoria tempi della centrale non cancella i codici dei radiocomandi appresi, sono due memorie esterne ben distinte.

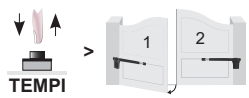
	1	Premere i pulsanti CODICI e TEMPI I LED L1 si accendono
	2	Attendere 10 secondi, fino a quando i LED L1 non si spengono.
	3	Rilasciare i pulsanti CODICI e TEMPI

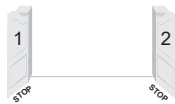

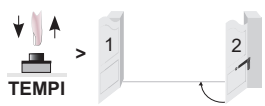
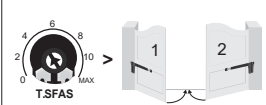
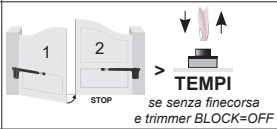

8 Apprendimento tempi

8.1 Apprendimento tempi NORMALE

1		Posizionare l' automazione in condizione di chiuso .
2		Porre in OFF l'interruttore 10 del DIP A
3		Premere il pulsante TEMPI * la prima anta (1° motore) parte in apertura
4		Dopo lo sfasamento impostato tramite il trimmer T.SFAS , la seconda anta (2° motore) parte in apertura
5		Attendere che la prima anta si apra completamente , se sono presenti i fincorsa passare al punto 6 , altrimenti premere il pulsante TEMPI per fermare la prima anta
6		A questo punto il 1° Motore si ferma, attendere l'arresto del 2° Motore
7		Da quando i 2 motori si saranno arrestati , lasciare trascorrere il tempo per cui l'automazione deve rimanere aperta (tempo di pausa)
8		Premere il pulsante TEMPI per iniziare la fase di chiusura la seconda anta (2° motore) parte in chiusura
9		Dopo lo sfasamento impostato tramite il trimmer T.SFAS , la prima anta (1° motore) parte in chiusura
10		Attendere che la seconda anta si chiuda completamente , premere il pulsante TEMPI , SOLO NEL CASO CHE non siano montati i fincorsa e il trimmer BLOCK sia impostato su OFF . <i>In tutti gli altri casi attendere la chiusura della prima anta.</i>
11		Attendere il completo arresto dell'automazione si avrà così la conferma del corretto apprendimento dei Tempi nella modalità NORMALE

* Dopo la prima pressione del pulsante TEMPI si può utilizzare anche il comando START dal morsetto 17 oppure dal radiocomando appreso.

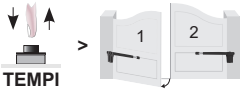
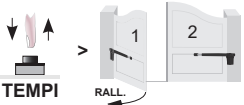
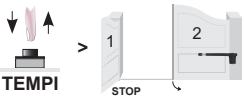
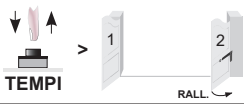
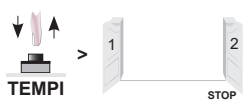

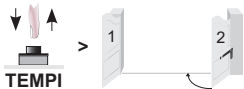
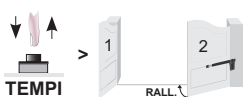

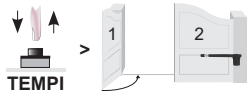
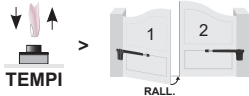
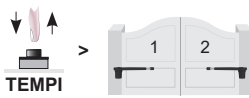
8.2 Apprendimento tempi AVANZATO

		L'automazione è in posizione di CHIUSO	
1		Porre in ON l'interruttore 10 del DIP A	L'automazione è in posizione di CHIUSO
2		* Premere il pulsante TEMPI	Il 1° motore parte in APRE
3		Premere il pulsante TEMPI (o START) ... se i rallentamenti sono attivi (trimmer V.RALL)...	il 1° motore rallenta in apertura
4		Premere il pulsante TEMPI (o START) (se non c'è il Fine Corsa Apre 1° Motore)	Il 1° Motore si ferma, parte il 2° Motore in APRE
4 a		... se è presente il Fine Corsa attendere l'arresto del 1° Motore	Il 1° Motore si ferma, parte il 2° Motore in APRE
5		Premere il pulsante TEMPI (o START) ... se i rallentamenti sono attivi (trimmer V.RALL)...	il 2° motore rallenta in apertura
6		Premere il pulsante TEMPI (o START) (se non c'è il Fine Corsa Apre 2°)	Il 2° Motore si ferma, parte il conteggio del tempo di PAUSA
6 a		... se è presente il Fine Corsa attendere l'arresto del 2° Motore	Il 2° Motore si ferma, parte il conteggio del tempo di PAUSA
		Lasciare trascorrere il tempo di PAUSA desiderato	
7		Premere il pulsante TEMPI (o START)	Il 2° motore parte in CHIUDE
8		Premere il pulsante TEMPI (o START) ... se i rallentamenti sono attivi (trimmer V.RALL)...	il 2° motore rallenta in chiusura



9		Premere il pulsante TEMPI (o START) (se non c'è il Fine Corsa Chiude 2°)	Il 2° Motore si ferma, parte il 1° Motore in CHIUDE
9 a		... se è presente il Fine Corsa attendere l'arresto del 2° Motore	Il 2° Motore si ferma, parte il 1° Motore in CHIUDE
10		Premere il pulsante TEMPI (o START) ... se i rallentamenti sono attivi (trimmer V.RALL.)...	il 1° motore rallenta in chiusura
11		Premere il pulsante TEMPI (o START) (se non c'è il Fine Corsa Chiude 1°)	Il 1° Motore si ferma. FINE apprendimento tempi AVANZATO.
11 a		... se è presente il Fine Corsa attendere l'arresto del 1° Motore	Il 1° Motore si ferma. FINE apprendimento tempi AVANZATO.

* Dopo la prima pressione del pulsante TEMPI si può utilizzare anche il comando START dal morsetto 17 oppure dal radiocomando appreso.

8.3 Apprendimento tempi APERTURA PEDONALE.

L'automazione è in posizione di CHIUSO			
	1	Premere e tener premuto il pulsante TEMPI fino a quando la centrale azionerà il 1° Motore in APRE, poi rilasciare il pulsante TEMPI	1° motore parte in APRE
	2	Premere il pulsante TEMPI	il 1° motore si arresta
		Lasciare trascorrere il tempo di PAUSA desiderato per l'apertura PEDONALE	
	3	Premere il pulsante TEMPI	Il 1° Motore parte in CHIUDE
	4	Premere il pulsante TEMPI (se non c'è il Fine Corsa Chiude 1°)	Il 1° Motore si ferma. L'anta Pedonale è chiusa. FINE.
	4 a	... se è presente il Fine Corsa attendere l'arresto del 1° Motore (PEDONALE) in chiusura	Il 1° Motore si ferma al Fine Corsa Chiude. L'anta Pedonale è chiusa. FINE

8.4 Apprendimento veloce TEMPO DI PAUSA





L'automazione è in posizione di PAUSA			
	1	Premere e rilasciare il pulsante TEMPI	I LED APRE e CHIUDE rimangono accesi
		Lasciare trascorrere il nuovo tempo di PAUSA desiderato	
	2	Premere e rilasciare il pulsante TEMPI	L'automazione parte in CHIUDE. Fine apprendimento veloce TEMPO di PAUSA

9 Istruzioni per l'utilizzo del TEST

La funzione TEST è compatibile con gli apparati più lenti in risposta (es. TRANSCIVER), di conseguenza in presenza di tali dispositivi la partenza della manovra di apertura può essere ritardata di qualche secondo. Inoltre si estende la possibilità di testare i dispositivi collegati anche sull'ingresso STOP.

Per consentire alla centralina di autorilevare se i dispositivi collegati sugli ingressi FOTO, FOTOSTOP (*Fotocellula B*) e STOP sono sotto TEST occorre eseguire questa procedura:

Eseguire i collegamenti per il TEST come da documentazione

	1	A centrale spenta porre in OFF il DIP 8 del DIP A
 LED	2	Alimentare la centrale e attendere il normale lampeggio del LED
	3	Porre in ON il DIP 8 del DIP A
 START	4	Eeguire una manovra di apertura con il comando START oppure l'apprendimento tempi se necessario (Par. 5.1)

In questo punto la centrale esegue la rilevazione dei dispositivi sotto TEST e quindi come detto in precedenza la partenza sarà ritardata di qualche secondo

12 Dichiarazione CE di conformità

(secondo Direttiva 2006/42/CE, Allegato II, parte B)

Il sottoscritto **Ernestino Bandera**,
Amministratore

DICHIARA CHE:



Azienda: EB TECHNOLOGY SRL
Indirizzo: Corso Sempione 172/5
 21052 Busto Arsizio VA Italia

Nome prodotto: START-S6XL BLOCK
 centrale elettronica di comando
 per 2 motori 230 Vac

IL PRODOTTO E' CONFORME a quanto previsto dalla direttiva comunitaria:**2006/42/CE**

DIRETTIVA 2006/42/CE DEL PARLAMENTO EUROPEO E DEL CONSIGLIO del 17 maggio 2006 riguardante il ravvicinamento delle legislazioni degli Stati membri relative alle macchine.

Riferimento: Allegato II, parte B (dichiarazione CE di conformità del fabbricante).

IL PRODOTTO E' CONFORME a quanto previsto dalle seguenti direttive comunitarie, così come modificate dalla Direttiva 2006/42/CE del consiglio del 14 ottobre 2004:**2014/35/CE**

Direttiva 2014/35/UE del Parlamento europeo e del Consiglio, del 26 febbraio 2014, concernente l'armonizzazione delle legislazioni degli Stati membri relative alla messa a disposizione sul mercato del materiale elettrico destinato a essere adoperato entro taluni limiti di tensione.

Riferimento alle norme armonizzate: EN 60335-1

2014/30/CE

Direttiva 2014/30/UE del Parlamento europeo e del Consiglio, del 26 febbraio 2014, concernente l'armonizzazione delle legislazioni degli Stati membri relative alla compatibilità elettromagnetica.

Riferimento alle norme armonizzate: EN 61000-6-2 EN 61000-6-3

IL PRODOTTO E' CONFORME ai requisiti essenziali richiesti dall'articolo 3 dalla seguente direttiva comunitaria, per l'uso al quale i prodotti sono destinati:**2014/53/CE (RED)**

Direttiva 2014/53/UE del Parlamento europeo e del Consiglio, del 16 aprile 2014, concernente l'armonizzazione delle legislazioni degli Stati membri relative alla messa a disposizione sul mercato di apparecchiature radio.

Riferimento alle norme: ETSI EN 300 220-3 ETSI EN 301 489-1 ETSI EN 301 489-3

Come indicato dalla direttiva 2006/42/CE si ricorda che non è consentita la messa in servizio del prodotto in oggetto finché la macchina, in cui il prodotto è incorporato, non sia stata identificata e dichiarata conforme alla direttiva 2006/42/CE.Dairago, li 01/06/2017
L'Amministratore
Ernestino BanderaEB TECHNOLOGY S.r.l.
Corso Sempione 172/5,
21052 Busto Arsizio VA ItaliaNOLOGO S.r.l.
via Cesare Cantù 26,
20020 Villa Cortese MI Italia
tel. +39 0331.430457
fax +39 0331.432496posta@ebtechnology.it
www.ebtechnology.itinfo@nologo.info
www.nologo.info

<p>DICHIARAZIONE DI CONFORMITA'</p> <p>Il sottoscritto, rappresentante il seguente costruttore, dichiara che l'apparecchio denominato</p> <p>START-S6XL BLOCK</p> <p>risulta conforme a tutte le norme tecniche relative al prodotto entro il campo di applicabilità delle Direttive Comunitarie 2006/42/CE, 2014/35/CE, 2014/30/CE e 2014/53/CE (RED)</p> <p>Sono state eseguite tutte le necessarie prove di radiofrequenza</p> <p>EB TECHNOLOGY SRL Corso Sempione 172/5 21052 Busto Arsizio (Va) Italia</p> <p>Questa dichiarazione viene emessa sotto la sola responsabilità del costruttore e, se applicabile, del suo rappresentante autorizzato.</p> <p>Busto Arsizio (Va) - Italia, 01/06/2017</p> <p>ERNESTINO BANDERA Amministratore</p>	<p>DECLARATION OF CONFORMITY</p> <p>The undersigned, representative of the following manufacturer, hereby certifies that the equipment known as</p> <p>START-S6XL BLOCK</p> <p>complies with all technical requirements concerning this product within the domain of application of the EC Directives 2006/42/CE, 2014/35/CE, 2014/30/CE and 2014/53/CE (RED)</p> <p>All necessary radiofrequency tests have been performed</p> <p>EB TECHNOLOGY SRL Corso Sempione 172/5 21052 Busto Arsizio (Va) Italy</p> <p>This declaration is rendered under the manufacturer's sole responsibility, and if applicable, under responsibility of his authorized representative.</p> <p>Busto Arsizio (Va) - Italia, 01/06/2017</p> <p>ERNESTINO BANDERA Administrator</p>	<p>DÉCLARATION DE CONFORMITÉ</p> <p>Le soussigné, représentant du constructeur suivant certifie que les appareils ci-dessus référencés</p> <p>START-S6XL BLOCK</p> <p>sont conformes à toutes les normes techniques relativement au produit dans le domaine d'application des Directives Européennes 2006/42/CE, 2014/35/CE, 2014/30/CE et 2014/53/CE (RED)</p> <p>Toutes les essais de radiofréquence nécessaires ont été effectués</p> <p>EB TECHNOLOGY SRL Corso Sempione 172/5 21052 Busto Arsizio (Va) Italy</p> <p>Cette déclaration est présentée sous la seule responsabilité du constructeur et, si applicable, de son représentant autorisé.</p> <p>Busto Arsizio (Va) - Italia, 01/06/2017</p> <p>ERNESTINO BANDERA Administrateur</p>
<p>KONFORMITÄTSZERTIFIKAT</p> <p>Der Unterzeichner bescheinigt, dass das Produkt</p> <p>START-S6XL BLOCK</p> <p>allen technischen Produktegesetzen, laut den Europäischen Gesetzen 2006/42/CE, 2014/35/CE, 2014/30/CE e 2014/53/CE (RED), entspricht.</p> <p>Alle Radiofrequenzprüfungen haben bei der nachstehenden Firma stattgefunden:</p> <p>EB TECHNOLOGY SRL Corso Sempione 172/5 21052 Busto Arsizio (Va) Italy</p> <p>Diese Bescheinigung wird unter der alleinigen Verantwortung des Herstellers ausgestellt und dort woanwenbar, auch unter der des befugten Vertreters.</p> <p>Busto Arsizio (Va) - Italia, 01/06/2017</p> <p>ERNESTINO BANDERA Verwalter</p>	<p>DECLARACIÓN DE CONFORMIDAD</p> <p>El abajo firmante, representante el fabricante siguiente, declara que el equipo denominado</p> <p>START-S6XL BLOCK</p> <p>es conforme con todas las normas técnicas correspondientes al producto en el campo de aplicación de las Directivas Comunitarias 2006/42/CE, 2014/35/CE, 2014/30/CE y 2014/53/CE (RED)</p> <p>Han sido realizadas todas las necesarias pruebas de radiofrecuencia.</p> <p>EB TECHNOLOGY SRL Corso Sempione 172/5 21052 Busto Arsizio (Va) Italy</p> <p>Esta declaración se expide bajo la exclusiva responsabilidad del fabricante y, si de aplicación, de su representante autorizado.</p> <p>Busto Arsizio (Va) - Italia, 01/06/2017</p> <p>ERNESTINO BANDERA Administrador</p>	<p>DECLARAÇÃO DE CONFORMIDADE</p> <p>O abaixo-assinado, representando o seguinte construtor declara que o aparelho denominado</p> <p>START-S6XL BLOCK</p> <p>é conforme a todas as normas técnicas relativas ao produto dentro o campo de aplicabilidade das Diretivas Comunitarias 2006/42/CE, 2014/35/CE, 2014/30/CE e 2014/53/CE (RED)</p> <p>Foram executadas todas as necessárias provas de rádio frequência.</p> <p>EB TECHNOLOGY SRL Corso Sempione 172/5 21052 Busto Arsizio (Va) Italy</p> <p>Esta declaração vem emitida somente com a responsabilidade do construtor e, se aplicável, do seu representante autorizado.</p> <p>Busto Arsizio (Va) - Italia, 01/06/2017</p> <p>ERNESTINO BANDERA Administrador</p>

- Single phase for 230 Vac 2 motors
- Universal control unit for 1 or 2 motors
- 433 MHz radio receiver included
- Self programming

Complete Operating Guide

START-S6XL BLOCK

Radio Receiver

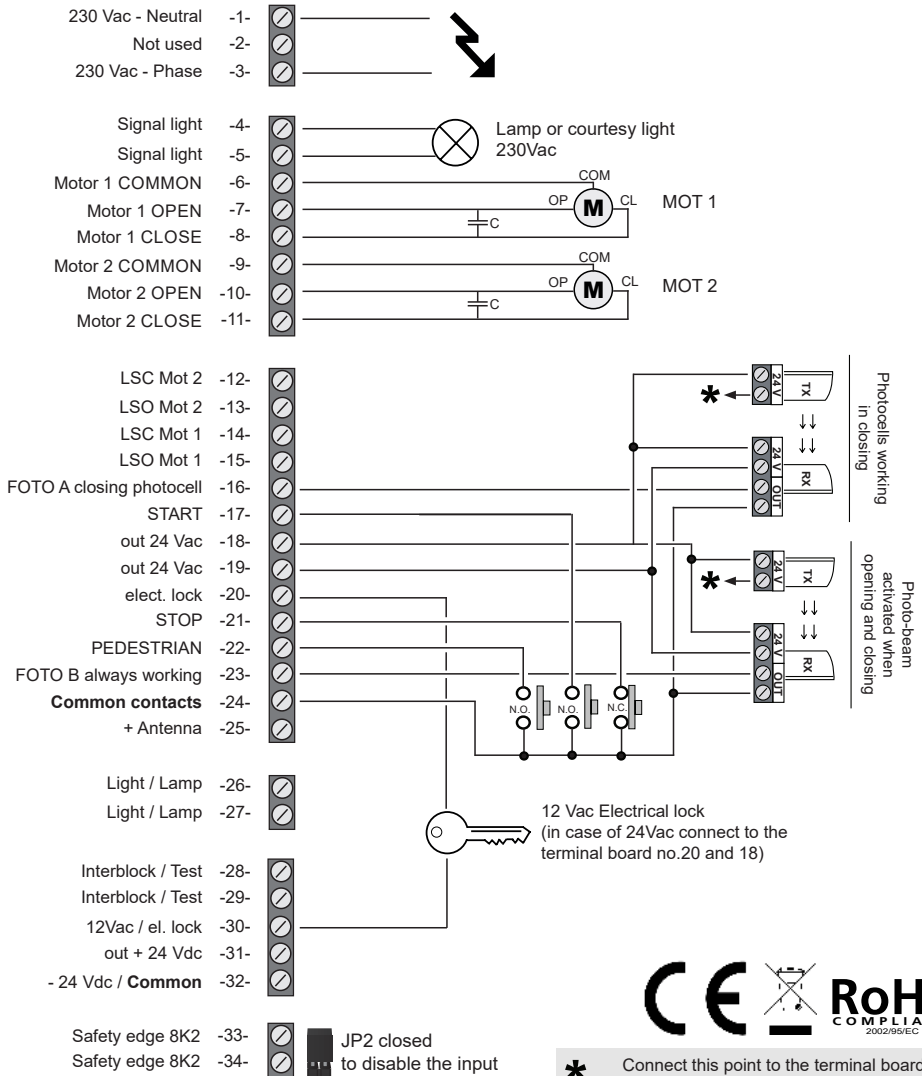

* Connect this point to the terminal board no. 28 for the photo-test, otherwise connect it to the terminal board no. 19



Premises

This manual provides all the specific information you need to familiarize yourself with and correctly operate your unit. Read it very carefully when you purchase the instrument and consult it whenever you have doubts regarding use and before performing any maintenance operations.

Safety precautions

Using the unit improperly and performing repairs or modifications personally will void the warranty. Nologo declines any responsibility for damages due to inappropriate use of the product and due to any use other than the use the product was designed for. Nologo declines any responsibility for consequential damages except civil liability for the products.

The gate should be conformed to the european law **EN 60204-1**, **EN 12445**, **EN 12453**. It is obliged to be conformed to the norms for the automated closing devices **EN 12453**, **EN 12445**, **EN 12978** and eventually nationa laws. The adjust of the force of the motor should be measured with a device according to the values of the norma **EN 12453**.

Environmental protection measures

Information regarding the environment for customers within the European Union. European Directive EC 2002/96 requires that units bearing this symbol on the unit and/or on the packaging be disposed of separately from undifferentiated urban wastes.



Be disposed of with the ormal household wastes. The owner is responsible for disposing of this product and other electrical and electronic equipment through specific waste collection facilities indicated by the government or local public agencies. Correct disposal and recycling help prevent any potentially negative impact on the environment and human health. To receive more detailed information regarding disposal of your unit, we recommend that you contact the competent public agencies, the waste collection service or the shop where you purchased the product.

Small legend

FCA / LSO	Open limit switch
FCC / LSC	Close limit switch
START	Control to drive the gate
PEDONALE	in sliding units: control partial opening
Vac	Alternate current
Vdc	Direct current
NC	Normally closed
NA / NO	Normally open
Isolated contact	Isolated from power supply

Index

Par.	Description	Pag.
2	Description of the product	4
2.1	Working features	
2.2	Fields of application	
2.3	Technical features	
3	Premises	5
3.1	Preliminary checks	
3.2	Type of electrical wires	
3.3	Connections	
4	Installation of the control board	6
4.1	Scheme and electrical connections	
4.2	Connection of the network tension	7
4.3	Motor connection	
4.4	Connection of the signal light	
4.5	Connection of a 24Vdc light	
4.6	Connection of Courtesy light	8
4.7	Connection of ANTENNA	
4.8	Connection of arrest devices STOP command	
4.9	Connection of the LSO and LSC LIMIT SWITCHES	
4.10	Connection of the commands START and PEDESTRIAN	9
4.11	Connection of LOCKING 12 Vac	
4.12	Power supply of ACCESSORIES	
4.13	Connection of the PHOTOCELLS A	10
4.14	Connection of the PHOTOCELLS A with TEST	
4.15	Connection of the PHOTOCELLS B	11
4.16	Connection of the PHOTOCELLS B with TEST	
4.17	Check of the connections	12
5	Functions and adjustments	12
5.1	Setting up with DIP B	
5.2	Use of the DIP A	14
5.3	Advanced Settings	15
6	Using the remote controls	16
6.1	FULL CANCELLATION of the memory	
6.2	ROLLING CODE activated	
6.3	Learning of the remote controls	16
8	Reset of the memory	
8	Time learning	17
8.1	Time learning: NORMAL WAY	
8.2	Time learning: ADVANCED SYSTEM	18
8.3	Time learning PEDESTRIAN WAY	19
8.4	Time learning: pause (fastest way)	20
9	Instruction for TEST	
10	Adjustment	21
11	Note	
11	Declaration of CE conformity	23

1 Introduction

1.1 Safety precautions

Using the unit improperly and performing repairs or modifications personally will void the warranty. The producer declines any responsibility for damages due to inappropriate use of the product and due to any use other than the use the product was designed for. The producer declines any responsibility for consequential damages except civil liability for the products.

1.2 Symbols and warning



Generic Danger

This is a warning and if it is not respect it can provoque material damage!



Read carefully the manual

Read carefully the manual before installing



Equipment under electrical tension

Installation only from qualified installers.

1.3 Security System

It is important to establish the “**MACHINE**“ risks and the requirements of the final user. In the photo the final user will fix the number of accessories to be installed. In the scheme the couple of the photo-beams A OPEN it has no effect while it inverts completely after closing. “**FOTO A2**” is the serial connection of the foto A or ALT connection. Check the synchronisation of the photo-beams which avoid interferences.

Swing gates

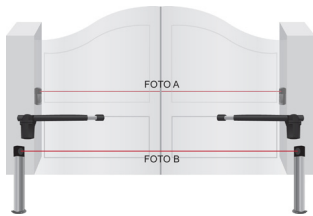

Sliding gates

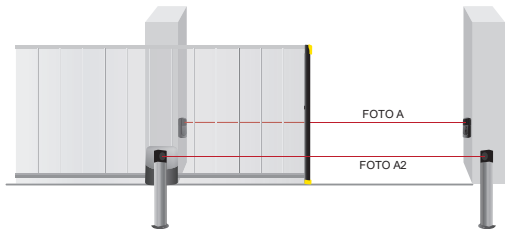













We recommend to install a STOP command for the immediatelly stop of the gate. The switch is a normally closed contact as shown in the par. 4.8

2 Description of the product

La START-S6XL BLOCK was created to suit various needs: both for door gates and sliding gates. The design adopted the most advanced techniques to guarantee the utmost immunity vs. noises, the maximum operating flexibility and to create a wide choice of available functions.

2.1 Working features

	Slow down
	Self learning of working times
	Electrical adjust of the force of the motor
	4 functions (apartment block included)
	Functions set up through a dip
	Free contact for light indicating the open gate
	Radio included which can manage codes rolling
	Small dimensions
	Pedestrian door (partial opening) with separate command
	Electrical lock and selecting reversing stroke
	Dip exclusion of all the safety inputs
	TEST function compatible with TRANSCIEVER

2.2 Fields of application

The START-S6XL BLOCK control board is designed to move gates, overhead garage doors, rolling shutters and automatic doors. It can be connected to an oleodynamic motor or to an electro-mechanical motor with a singlephase motor, working on 230 Vac.

2.3 Technical features

Dimensions	150 x 135 x 50	mm
Weight	500	g
MAX power of single motor	1 750 4	HP W A
MAX power of signal light	40	W
MAX absorption with clean contact	2	A
MAX absorption 24 Vac (clamps 18-19)	300	mA
MAX absorption 12 Vac (clamps 19-30)	600	mA
MAX absorption 24 Vdc (clamps 31-32)	100	mA

3 Premises

3.1 Preliminary checks

Making the correct choice of installation is essential to ensuring adequate safety and good protection against atmospheric agents. Remember that the control unit contains powered parts and electronic components which by their very nature are sensitive to infiltrations and moisture. The control unit is supplied in a container which guarantees an IP55 protection rating if adequately installed. Install the control unit on a permanent surface that is perfectly flat, adequately protected against impacts and at least 40 cm off the ground. The cables must enter the control unit from the bottom only; we recommend using wire leads and water-tight connections. When using tubing that could fill up with water or if the tubing comes from an underground well, the wires must enter a first shunting box placed at the same height as the control unit and then, from there, the wires must be passed into the container holding the control unit, again entering from the bottom. This prevents any evaporation of the water in the tubing from forming condensation inside the control unit itself.

3.2 Type of electrical wires

Depending on the installation, the type and number of devices installed, the number of cables needed can vary. The table below shows the cables needed for a typical installation. The cables used in the installation must be IEC 60335 compliant

⇒	Line of the power supply	Cable 3x1,5 mm ²
⇒	Cable motor	Cable 4 x 1,5 mm ²
⇒	Signal light	Cable 2x1,5 mm ²
⇒	Radio antenna	Shielded cable type RG58
⇒	Key selector	Cable 3x0,5 o 0,75 mm ²
⇒	Photo Rx	Cable 4x0,5 o 0,75 mm ²
⇒	Photo Tx	Cable 2x0,5 o 0,75 mm ²

3.3 Connections

To guarantee operator safety and to prevent damaging the components, never make connections or insert wireless receiver boards while the control unit is powered.









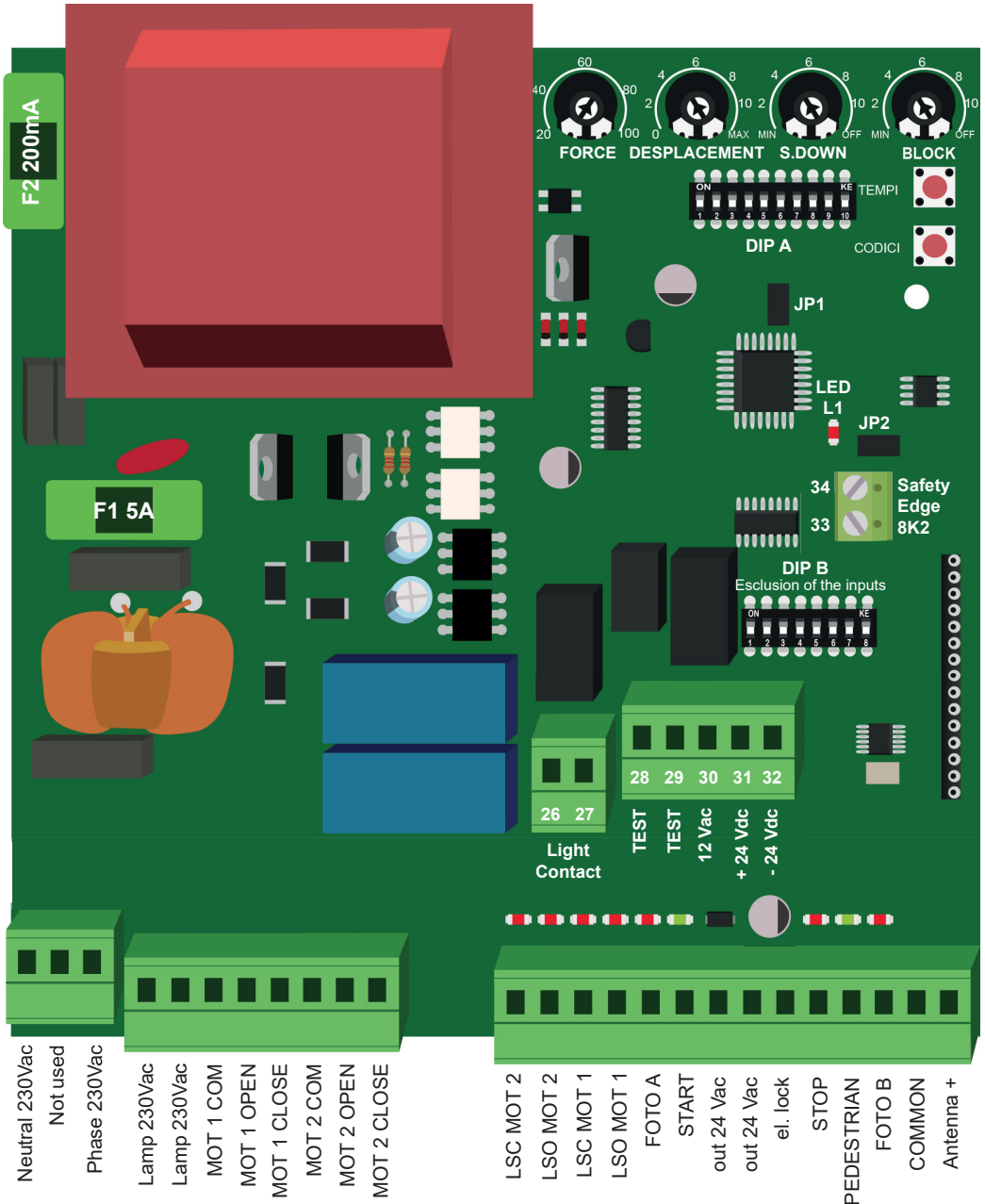





















- Power the control unit through a 3 x 1.5 mm² cable. If the distance between the control unit and the ground system connection is more than 30 m, a ground plate must be installed in proximity to the control unit.
- If the motors do not have a cable, use the 4 x 1.5 mm² cable (open + close + common + ground).
- In connecting the part with an extremely low safety voltage, use cables with a minimum section of 0.5 or 0.75 mm².
- Use shielded cables if the length exceeds 30m and connecting the ground braid only from the side of the control unit.
- Do not connect the cables in underground cases even if they are water-tight.
- If they are not used, the inputs to the Normally Closed (NC) contacts must be jumpered to the common.
- If the same input has more than one contact (NC), they are placed in series.
- If they are not used, the inputs to the Normally Open (NO) contacts are left loose.
- If the same input has more than one contact (NO), they are to be placed in series.
- The contacts must be mechanical and free of any potential

Remember that systems for automatic gates and doors must be installed by highly qualified technicians only and in full compliance with current law.

4 Installation of the control board

4.1 Scheme and electrical connections



230 Vac Neutral	1		230 Vac Power supply 50 Hz NEUTRAL
Not used	2		
230 Vac Phase	3		230 Vac Power supply 50 Hz PHASE
Signal light	4		Outputs for LAMP (flashing light electronic card) or 230 Vac COURTESY LIGHT, maximum power of the lamp 40 or 100W
	5		
M 1 Com	6		Output for motor connection 1 COMMON pole
M 1 Open	7		Output for motor connection 1 pole OPEN
M 1 Close	8		Output for motor connection 1 pole CLOSE
M 2 Com	9		Output for motor connection 2 COMMON pole
M 2 Open	10		Output for motor connection 1 pole OPEN
M 2 Close	11		Output for motor connection 1 pole CLOSE
LSC M2	12		Input Closing Limit Switches motor no. 2
LSO M2	13		Input Opening Limit Switches motor no. 2
LSC M1	14		Input Closing Limit Switches motor no. 1
LSO M1	15		Input Opening Limit Switches motor no. 1
Photo A	16		Input photocell A: working only by closing
START	17		Input command bi-stable START
24Vac	18		Out 24Vac
24Vac	19		Out 24Vac
12Vac Serrat.	20		Output for electrical lock 12Vac 50Hz 1A
STOP	21		STOP input
PEDESTRIAN	22		Input for bi-stable function partial opening PEDESTRIAN
Photo B	23		Input photocell B working in closing and in opening
Common	24		Common for all inputs: services, Security devices, coaxial antenna cable sock
Antenna +	25		Input for antenna (antenna cable)
Light	26		Contact for light (for flashing light without electronic card)
Light	27		
Interblock/Test	28		Interblock / Test
Interblock/Test	29		Interblock / Test
12Vac	30		Out 12Vac
24Vdc +	31		Out 24Vdc +
Com 24Vdc -	32		Out 24Vdc - Common for inputs: services and safety
Safety edge 8K2	33		Safety edge 8K2 (JP2 closed to disable the input)
	34		

4.2 Connection of the network tension

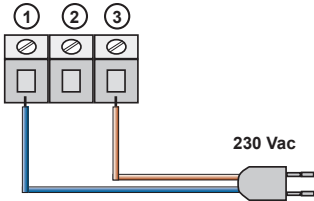

230 Vac. The line of power supply towards the control board must always be protected with an electromagnetic switch or with a 5a fuse couple.

A differential switch is recommended but not indispensable if it is already present in the installation.

4.3 Motor connection

Be particularly careful in not mistaking the Opening pole with the Closing pole.

In case you have doubts about the correct connections, put manually, if possible, the gate in the middle position of the course. Be ready to block the system with the STOP command.

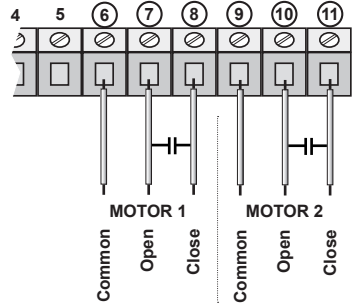

4.4 Connection of the SIGNAL LIGHT

Signal light complete with intermittent electronic card

Signal light without intermittent electronic card

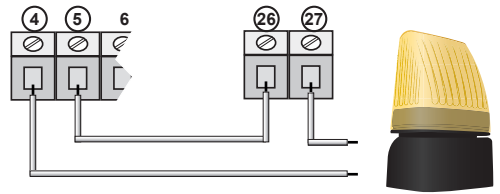
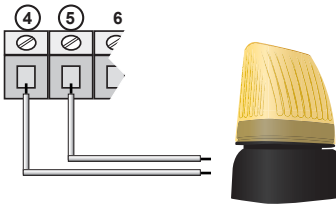

! If you are expecting to use the test on the photocells or for a 24V light, you can't use this connection.

4.5 Connection of a 24Vdc light with an open and moving gate

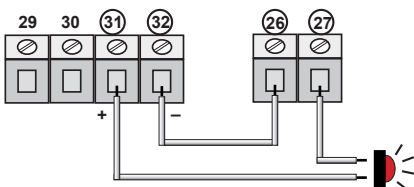

! If you are expecting to use the test on the photocells or for a signal light, you can't use this connection.

● Keep pressed the button TEMPI for a fixed or a flashing light until the LED-L1 starts flashing when the gate is closing.

4.6 Connection of Courtesy light

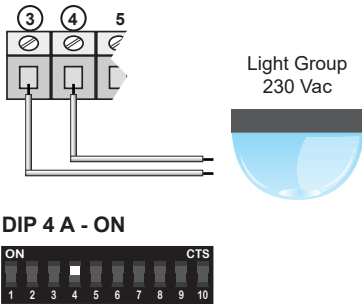

4.7 Connection of ANTENNA

If you are using a piece of stiff wire instead of an antenna, to obtain a 433Mhz frequency you have to cut it off to 17 cm e connect it to the clamp no. 25

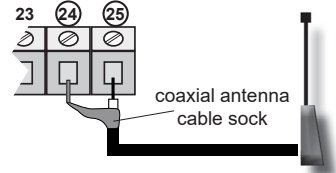

ONLY CONNECT THE ANTENNA AFTER THE MEMORIZATION OF THE RADIO CODES IS DONE!!!

4.8 Connection of arrest devices STOP command

Connection of the STOP command:

Button: stops and inhibits temporarily the control unit until a new command.

Switch: keeps the automation blocked until a new retrieval is ordered.

! If the STOP input is NOT used put the DIP 6 B on ON.

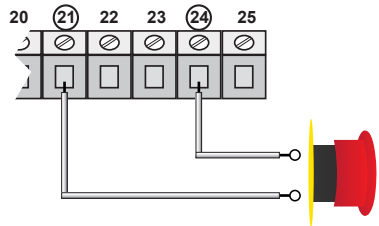

You need to use any kind of button or contact provided it is type N.C. (normally closed) to connect the safety devices. If there are several safety devices they have to be connected in series.

4.9 Connection of the LSO and LSC LIMIT SWITCHES

The picture shows the connection of both limit switches.

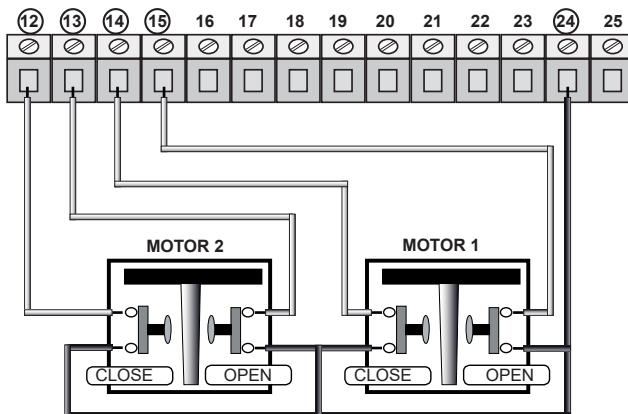

! If the LSO or LSC inputs aren't in use, follow the instructions you find in chapter n. 5.1

The contacts of the limit switches must be type N.C. (normally closed)

4.10 Connection of the commands "START" and "PEDESTRIAN"

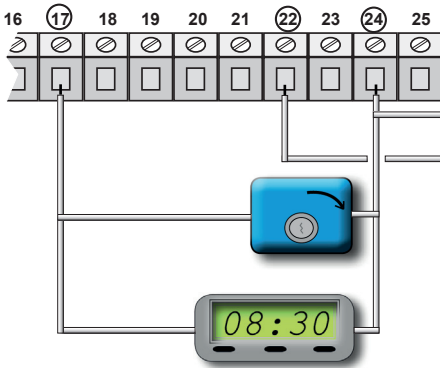

The connection of the command for pedestrian opening can be realized on every button or contact as soon as it is type N.O. (normally opened).

The connection of the opening command START can be realized on every button or contact as soon as it is type N.O. (normally opened). If you have several devices to connect you need to connect them in parallel.

By using the clamps no. 17 and no. 24 you can connect a TIMER to program the openings of the gate. The contact of your timer must be a type N.O. and must stay in a close mode the whole time the gate remains opened. If there is an opening command connection on the clamp no. 17, connect in parallel.

4.11 Connection of Elec. lock 12 Vac

Aside is the layout of the connection of the 12 Vac elec. lock:

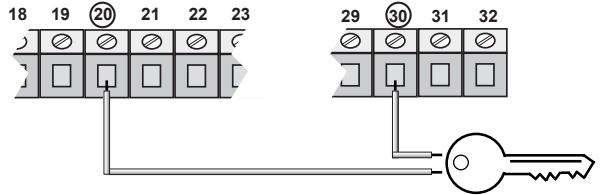

4.12 Power supply of ACCESSORIES

Below the layout of the connection for a correct power supply of the accessories. keep in mind that between the clamps from no.19 to no. 30 there is a tension of 12 Vac

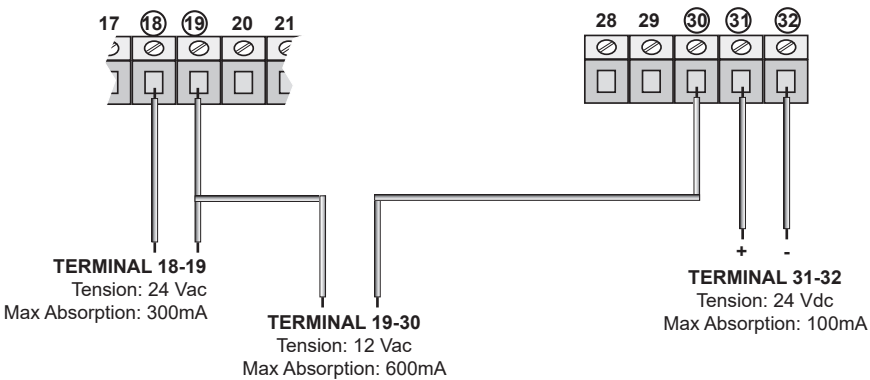

4.13 Connection of the PHOTOCELLS A (only in closing mode) 24 Vac

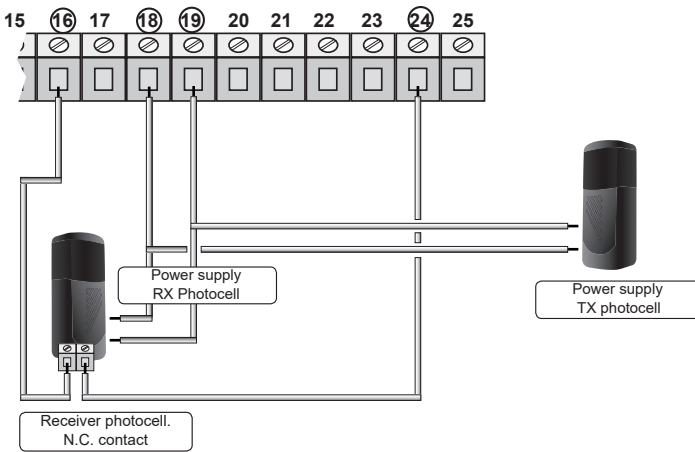

The contact of the photocell's receiver must be:

- **clean** (isolated from the power supply voltage)
- **type N.C.** (normally closed)

If you are using several sets of photocells the connection must be done in series.

! If the input PHOTO A is not used put the DIP 5 B in ON mode

4.14 Connection of the PHOTOCELLS A 24 Vac with phototest

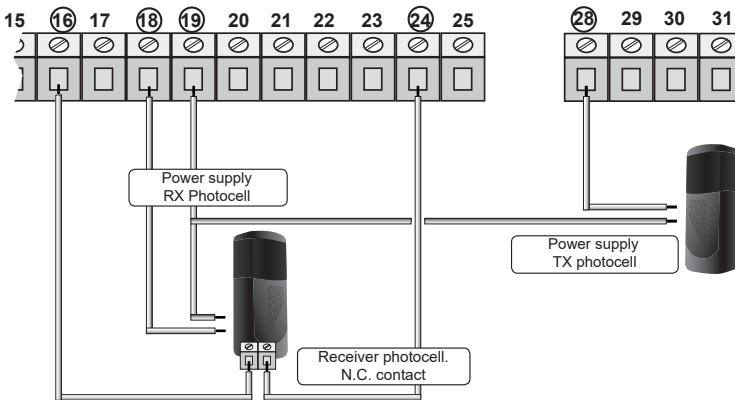

The contact of the photocell's receiver must be:

- **clean** (isolated from the power supply voltage)
- **type N.C.** (normally closed)

The TEST on the photocells can only ensure the correct working of the automation if said photocells are regularly working. The control board will perform a test before every opening. In case of malfunction of the photocells the control board will turn on the signal light for 5 seconds and will not allow the automation.

To activate the TEST function read carefully and follow the instructions in chapter no. 9

4.15 Connection of the PHOTOCELLS B (both in closing and opening) 24 Vac

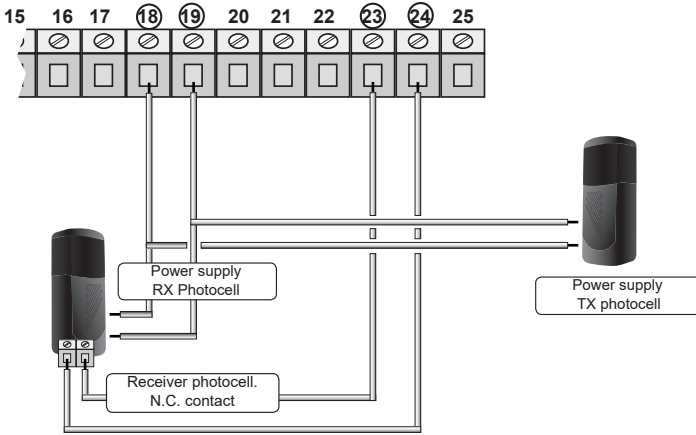

The contact of the photocell's receiver must be:

- **clean** (isolated from the power supply voltage)
- **type N.C.** (normally closed)

If you are using several sets of photocells the connection must be done in series.

! If the input PHOTO B is not used put the DIP 6 B in ON mode

4.16 Connection of the PHOTOCELLS B - 24 Vac with phototest

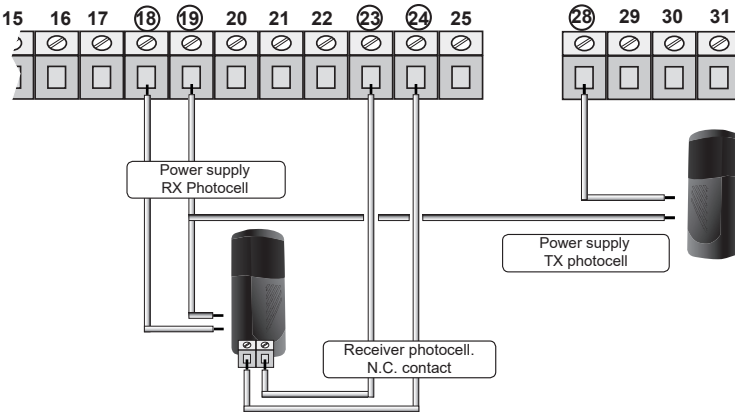

The contact of the photocell's receiver must be:

- **clean** (isolated from the power supply voltage)
- **type N.C.** (normally closed)

4.17 Check of the connections

When the control board is powered, the “led” lights, that are placed on the inputs, are lit up when there is a closed contact towards the common on the input.

(In case of red led are not all lit on, check the connections)

The **red leds** on the inputs **LSC - LSO - STOP - PHOTO** are normally always switched **ON**

The **green leds** on the command inputs **START - PEDESTRIAN** are normally switched **OFF**

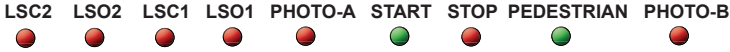

If LED L1 flashes but it doesn't turn off completely it means that the 8k2 input is in Stand-by or has been excluded.

Now you will see the state of the automation through the led:

- LED L1** ●
- One flash = standard function / condition
 - Two flashes normal condition of the control unit with rolling code function activated
 - None flashes JP1 is closed and the function activated is the advanced time programming













5 Functions and adjustments

The control board has several micro-switches to activate a lot of functions in order to find suitable solutions for the user and to make the installation more safe.

5.1 Setting up with DIP B





	1-ON	LSC M2 12	Exclusion of the inputs closes limit switches motor no.2
	2-ON	LSO M2 13	Exclusion of the inputs opens limit switches motor n. 2
	3-ON	LSC M1 14	Exclusion of the inputs of the closing limit switches motor no.1
	4-ON	LSO M1 15	Exclusion of the inputs of the opening limit switches motor no.1
	5-ON	Photocell A 16	Exclusion of the input of photocell working in closing
	6-ON	Photocell B 23	Exclusion input photocell always activated
	7-ON	STOP 21	Exclusion of the input stop
	8-ON	Radioreceiver	It activates the radio-receiver

5.2 Use of the DIP A

	1-OFF 2-OFF	Automatic 1	By every order it inverts: open and close . It closes automatically at the end of the pause time
	1-ON 2-OFF	Condominium	In opening and pause time it doesn't accept commands. it re-closes automatically at the end of the pause time.
	1-OFF 2-ON	Semi automatic	By every command it follows the procedure open-stop-close-stop-open etc. It doesn't re-close automatically
	1-ON 2-ON	Automatic 2	By every command it follows open-stop-close-stop-open etc. It recloses automatically at the end of the pause time.
	3-ON	Reversing stroke	This function starts a closing thrust at the beginning or at the end of the manoeuvre to make easy the work of the electrical lock.
	4-ON	Courtesy light	In the output of the terminal board 4 and 5 there is tension at the beginning of the opening till 2 minutes after closing, useful to power the courtesy light.
	5-ON	Pre-lighting	It ables the pre-lighting before each manoeuvre.
	6-ON	Crossing detector	As the photocells detect a crossing, the control board opens completely then closes but 1 sec. before according to the pause time, when the obstacle is gone.
	7-ON	Lamp in pause	The lamp is working in the pause time, too.
	8-ON	Phototest	Activates the phototest (in presence of TRANSCEIVER, see Chap no. 9)
	9-ON	Opening displacement	If you put the DIP 9 in ON the opening displacement will be at 2 seconds. The closing displacement time can be chosen with the trimmer "displacement".
	10-ON	Programming time, advanced system	It activate the advanced working time (JP1 closed)

5.3 Advanced Settings

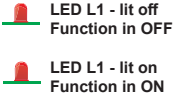
To programm the advanced setting, make as follow:



	1	Make sure that the gate is closed and JP1 closed , too.
	2	LED L1 stops flashing, and the LED L1 of TIMES (times) will flash according to the number of choosen functions.
<p>one flash</p>	1 motor	The control unit make work the motor no.1 and no. 2 in the same time. The program of the working time will be done only for motor no. 1
<p>2 flashes</p>	“Death man” function	The command START open, the PARTIAL OPENING closes. Motors stops immediatelly when the button will be released
<p>3 flashes</p>	Industrial use	The Partial Opening became a closes contact and the START follow the logic of dip 1 and 2.
<p>4 flashes</p>	Soft-start	When the gate is opening, the speed increases
	3	After LED L1 has flashes for the choosen functions, LED will turned off if the fuction was in OFF position or it will lit on if the function is in ON .
	4	To change the ON-OFF position, press and release the button CODES .
	5	To return to the normal state, bring JUMPER JP1 to OPEN

6 Using the remote controls

This receiver can manage standard codes from 12 till 64 bit and rolling codes HCS®. The first learned transmitter establish the code's type that the receiver has to manage, it means that the transmitter has to have the same code's type. Concerning the rolling codes it is possible to activate or deactivate the key's control and the rolling counter. With this function you can choose the security level of the receiver.

6.1 FULL CANCELLATION of the memory

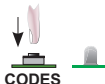
This operation cancels all previous memorized codes. It is not contemplated the cancellation of a single remote control code. It is necessary to reset the memory before learning the first remote control to avoid the remaining of previously memorized codes that aren't in use in the installation. The cancellation of the memory (all codes) is possible only when the gate is closed.

	1	Make sure that the gate is in CLOSED position. Press and keep pressed the CODES BUTTON
	2	Wait for the LED L1 to start flashing, then release it. Wait until the reset of the memory.



6.2 ROLLING CODE activated

Fixed code MODE (L1 - one flash)

The receiver manages standard codes from 12 to 64 bit and HCS® rolling code (only the fixed part)

Complete rolling code (L1 - flashes twice):

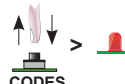

You can control the rolling code counter and the remote cannot be duplicated



	1	Press and release the button codes, LED L1 will lit on.
	2	Press and release the button CODES again, LED L1 flashes and lit on
	3	Press the button CODE again, LED L1 flashes twice, it activate the rolling code counter.
	4	To return to the fixed code, repeat the operation from point no.1 in this way LED L1 will flash only once.

6.3 Learning of the remote controls

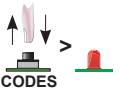
The remote controls can be learnt **ONLY** when the gate is **CLOSED**.

ALWAYS PERFORM THE LEARNING WITHOUT CONNECTING THE ANTENNA TO THE CLAMPS NO. 24-25

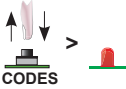
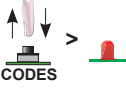
	1	Make sure that the gate is in CLOSED position
	2	Press and release the CODES button, the LED L1 will stay lit.
	3	Press the button of the remote control, ex: button no.1: if it is memorized LED L1 will flash

	1	Press and release the CODES button, the LED L1 will stay lit.
	2	Press again the CODES button, the LED L1 will flash and stay lit
	3	Press the button of the remote control, ex: button no.2: if it is memorized LED L1 will flash

- If you need to learn a new remote control repeat the same operation.



- When you push the remote control's button and the L.E.D. codes is switched ON, it means that the remote control is not compatible

- When you push the remote control's button and the L.E.D. codes flashes slowly, it means that the memory is FULL.

- In this card is not previewed the cancellation of a single remote control's code.



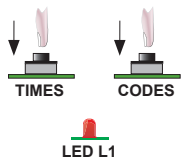

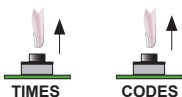



7 Reset of the memory

The reset of the memory programm the standard values of the remote controls. It doesn't cancel the codes: there are two different memories.

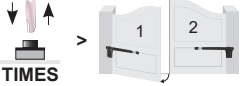
	1	Press the buttons CODES and TIMES LED L1 lit ON
	2	Wait 10 seconds until LED L1 will switch OFF
	3	Release the buttons CODES and TIMES

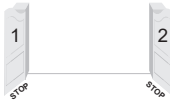

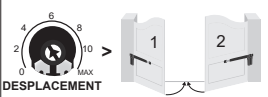
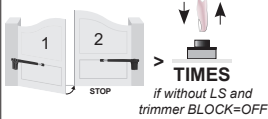



8 Time learning

8.1 Time learning: NORMAL WAY

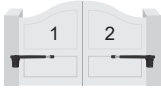
1		<p>The gate is in closed position</p>
2		<p>Put in OFF the switch no. 10 of the DIP A</p>
3		<p>Push the button TIMES * The first motor OPENS</p>
4		<p>After the displacement adjust the trimmer T.SFAS (displacement time) the second motor OPENS</p>
5		<p>Wait that the first leaf is completely open, if the limit switches are available read from point no. 6 otherwise press the button TIMES (times) to stop the first leaf.</p>
6		<p>Now the 1st motor stops, wait until the 2nd Motor stops</p>
7		<p>When both motors stop, let the time leave until the gate should be opened (pause time)</p>
8		<p>Press the button TIMES (times) to start the closing of the 2nd time (2nd motor)</p>
9		<p>After the displacement (adjusted with TRIMMER), the first leaf (1st motor) is closing.</p>
10		<p>Wait the 2nd leaf will close completely, press the button TIMES (times), ONLY IN CASE THE LIMIT SWITCHES ARE NOT AVAILABLE, and the TRIMMER BLOCK is in OFF position.</p>
11		<p>Wait the gate is completely closed, the correct program of the working time will be confirmed.</p>

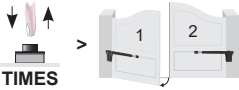
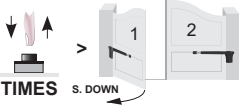
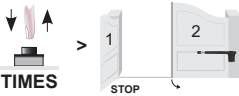
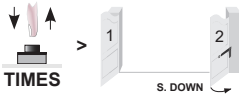
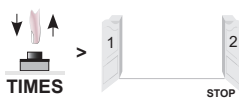
* After the first push of the **TIMES** button you can use the **START** command from the clamp no.17 or from the learned remote control.

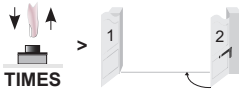

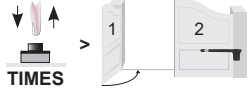
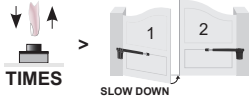
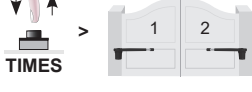

8.2 Time learning: ADVANCED SYSTEM

	<p>The gate is in CLOSED position</p>	
<p>1</p> 	<p>Put and leave in ON the DIP 10A</p>	<p>The gate is in closed position</p>
<p>2</p> 	<p>* Push the button TIMES</p>	<p>The first motor OPENS</p>
<p>3</p> 	<p>Push the button TIMES (or START) ... If the slowing down is activated trimmer see. Slow down ...</p>	<p>The first motor slows down when opening</p>
<p>4</p> 	<p>Push the TIMES button (or START) (if the opening limit switches of motor no.1 is not available).</p>	<p>Motor no.1 stops, then motor no. 2 OPENS</p>
<p>4 a</p>	<p>... If the limit switch is available wait until the first motor stops</p>	<p>Motor no.1 stops, then motor no. 2 OPENS</p>
<p>5</p> 	<p>Push the TIMES button (or START) if the slowing down is activated (trimmer V. Slow down) ...</p>	<p>The second motor slows down when opening</p>
<p>6</p> 	<p>Push the button TIMES (or START) (if the opening limit switches motor no. 2 is not available)</p>	<p>The second motor stops, the counting of the pause time starts</p>
<p>6 a</p>	<p>... If the limit switch is available wait until motor no. 2 stops</p>	<p>2° motor stops, the counting of the pause time starts</p>
	<p>Let the required pause time run...</p>	
<p>7</p> 	<p>Push the TIMES button (or START)</p>	<p>The second motor CLOSES</p>
<p>8</p> 	<p>Push the TIMES button (or START) if the slowing down is activated (trimmer see Slow down)</p>	<p>The second motor slows down when closing</p>



9		Push the TIMES button (or START) (if the closing limit switch of motor no.2 is not available)	The second motor stops, the first motor CLOSES
9 a		... if the limit switch is available wait until motor no. 2 stops	The 2° motor stops, the 1° motor CLOSES
10		Push the TIMES button (or START) ...if the slowing down is activated (trimmer see Slow down)...	The motor no.1 slows down when closing
11		Push the button TIMES (or START) ... if the closing limit switches of motor no.1 is not available...	Motor no.1 stops. End of ADVANCED LEARNING TIME
11 a		... if the limit switches is available wait the stop of motor no.1	Motor no.1 stops. End of ADVANCED LEARNING TIME.

* After the first push of the TIMES button you can use the START command from the clamp no.17 or from the learned remote control

8.3 Time learning PEDESTRIAN WAY

The gate is in closed position			
	1	Press and keep pressed the TIMES button till the control board starts motor no. 1 in OPEN, then release the TIMES button	Motor no.1 OPENS
	2	Press the TIMES button	Motor no.1 CLOSES
		Let the desired pause time run for the PEDESTRIAN OPENING	
	3	Press the TIMES button	Motor no.1 CLOSES
	4	Push the button TIMES (if the closing limit switches of motor no.1 is not available)	Motor no.1 stops. The pedestrian door is closed. End
	4 a	... If the limit switch is available wait until the motor no.1 (pedestrian use) stops in its closing	Motor no.1 stops by closing limit switches. The pedestrian door is closed. End.

8.4 Time learning: pause (fastest way)





The gate is in PAUSE			
	1	Press and release the TIMES button	The L.E.D. lights for opening and closing are witched ON
		Let the new pause time run...	
	2	Press and release the TIMES button	The gate CLOSES. End of the fast learning time and PAUSE TIME.

9 Instruction for TEST

The TEST function is compatible with devices with slow reponse (for example TRANSCIEVER) so when those devices are available the response time can be slower. You can test the devices in the STOP input.

Follow this procedure to know if some devices connected of the inputs FOTO, FOTOSTOP (photocell B) and STOP are under TEST.

Connect for the TEST

	1	When the control is switched OFF, put in OFF dip 8 of DIP A
 LED	2	Power the control unit and wait the standard flash of the Led
	3	Put in ON DIP 8 of DIP A
 START	4	Let the gate open with a START commande or the time learning if necessary

Now the control unit check ethe devices under TEST and the depart of the doors can be delayed

12 Declaration of CE conformity

(according to EC Directive 2006/42, Attachment II, part 1, ses. A)

The undersigned **Ernestino Bandera**,
Administrator

DECLARES THAT:



Factory:

EB TECHNOLOGY SRL

Address:

Corso Sempione 172/5
21052 Busto Arsizio VA Italy

Product's name::

START-S6XL BLOCK
Single phase for 230 Vac 2 motors

THE PRODUCT COMPLIES	with what is outlined in the European Community directive:
2006/42/CE	EC DIRECTIVE 2006/42 ISSUED BY THE EUROPEAN PARLIAMENT AND COUNCIL on may 17, 2006 harmonizing the legislation of the member countries regarding machinery.

Reference: Attachment II, part 1, ses. A (EC Declaration of Conformity issued by the manufacturer).

THE PRODUCT COMPLIES	with what is outlined in the European Community directives:
2014/35/CE	DIRECTIVE 2014/35/EU OF THE EUROPEAN PARLIAMENT AND OF THE COUNCIL of 26 February 2014 on the harmonisation of the laws of the Member States relating to the making available on the market of electrical equipment designed for use within certain voltage limits.

Reference to harmonized standards: EN 60335-1

2014/30/EU	DIRECTIVE 2014/30/EU OF THE EUROPEAN PARLIAMENT AND OF THE COUNCIL of 26 February 2014 on the harmonisation of the laws of the Member States relating to electromagnetic compatibility.
-------------------	---

Reference to harmonized standards: EN 61000-6-2 EN 61000-6-3

IL PRODOTTO E' CONFORME	with the essential requirements of article 3 of the following European Community Directive, for the use for which the product is designede
2014/53/CE (RED)	DIRECTIVE 2014/53/EU OF THE EUROPEAN PARLIAMENT AND OF THE COUNCIL of 16 April 2014 on the harmonisation of the laws of the Member States relating to the making available on the market of radio equipment

Reference to harmonized standards: ETSI EN 300 220-3 ETSI EN 301 489-1 ETSI EN 301 489-3

The directive 2006/42/CE remind that it is not allowed the function of the product until the machine, for which the product is included, is not identifty and declared conformed to the 2006/42/CE directive.

EB TECHNOLOGY S.r.l.
Corso Sempione 172/5,
21052 Busto Arsizio VA Italy

NOLOGO S.r.l.
via Cesare Cantù 26,
20020 Villa Cortese MI Italy
tel. +39 0331.430457
fax. +39 0331.432496

Dairago, 01/06/2017
the Administrator
Ernestino Bandera

posta@ebtechnology.it
www.ebtechnology.it

info@nologo.info
www.nologo.info



<p>DICHIARAZIONE DI CONFORMITA'</p> <p>Il sottoscritto, rappresentante il seguente costruttore, dichiara che l'apparecchio denominato</p> <p>START-S6XL BLOCK</p> <p>risulta conforme a tutte le norme tecniche relative al prodotto entro il campo di applicabilità delle Direttive Comunitarie 2006/42/CE, 2014/35/EU, 2014/30/EU e 2014/53/CE</p> <p>Sono state eseguite tutte le necessarie prove di radiofrequenza</p> <p>EB TECHNOLOGY SRL Corso Sempione 172/5 21052 Busto Arsizio (Va) Italia</p> <p>Questa dichiarazione viene emessa sotto la sola responsabilità del costruttore e, se applicabile, del suo rappresentante autorizzato.</p> <p>Busto Arsizio (Va) - Italia, 01/06/2017</p> <p>ERNESTINO BANDERA Amministratore</p>	<p>DECLARATION OF CONFORMITY</p> <p>The undersigned, representative of the following manufacturer, hereby certifies that the equipment known as</p> <p>START-S6XL BLOCK</p> <p>complies with all technical requirements concerning this product within the domain of application of the EC Directives 2006/42/CE, 2014/35/EU, 2014/30/EU and 2014/53/CE</p> <p>All necessary radiofrequency tests have been performed</p> <p>EB TECHNOLOGY SRL Corso Sempione 172/5 21052 Busto Arsizio (Va) Italy</p> <p>This declaration is rendered under the manufacturer's sole responsibility, and if applicable, under responsibility of his authorized representative.</p> <p>Busto Arsizio (Va) - Italia, 01/06/2017</p> <p>ERNESTINO BANDERA Administrator</p>	<p>DÉCLARATION DE CONFORMITÉ</p> <p>Le soussigné, représentant du constructeur suivant certifie que les appareils ci-dessus référencés</p> <p>START-S6XL BLOCK</p> <p>sont conformes à toutes les normes techniques relativement au produit dans le domaine d'application des Directives Européennes 2006/42/CE, 2014/35/EU, 2014/30/EU et 2014/53/CE</p> <p>Toutes les essais de radiofréquence nécessaires ont été effectués</p> <p>EB TECHNOLOGY SRL Corso Sempione 172/5 21052 Busto Arsizio (Va) Italy</p> <p>Cette déclaration est présentée sous la seule responsabilité du constructeur et, si applicable, de son représentant autorisé.</p> <p>Busto Arsizio (Va) - Italia, 01/06/2017</p> <p>ERNESTINO BANDERA Administrateur</p>
<p>KONFORMITÄT SZERTIFIKAT</p> <p>Der Unterzeichner bescheinigt, dass das Produkt</p> <p>START-S6XL BLOCK</p> <p>allen technischen Produktegesetzen, laut den Europäischen Gesetzen 2006/42/CE, 2014/35/EU, 2014/30/EU e 2014/53/CE, entspricht.</p> <p>Alle Radiofrequenzprüfungen haben bei der nachstehenden Firma stattgefunden:</p> <p>EB TECHNOLOGY SRL Corso Sempione 172/5 21052 Busto Arsizio (Va) Italy</p> <p>Diese Bescheinigung wird unter der alleinigen Verantwortung des Herstellers ausgestellt und dort wohnenbar, auch unter der des befugten Vertreters.</p> <p>Busto Arsizio (Va) - Italia, 01/06/2017</p> <p>ERNESTINO BANDERA Verwalter</p>	<p>DECLARACIÓN DE CONFORMIDAD</p> <p>El abajo firmante, representante el fabricante siguiente, declara que el equipo denominado</p> <p>START-S6XL BLOCK</p> <p>es conforme con todas las normas técnicas correspondientes al producto en el campo de aplicación de las Directivas Comunitarias 2006/42/CE, 2014/35/EU, 2014/30/EU y 2014/53/CE</p> <p>Han sido realizadas todas las necesarias pruebas de radiofrecuencia.</p> <p>EB TECHNOLOGY SRL Corso Sempione 172/5 21052 Busto Arsizio (Va) Italy</p> <p>Esta declaración se expide bajo la exclusiva responsabilidad del fabricante y, si de aplicación, de su representante autorizado.</p> <p>Busto Arsizio (Va) - Italia, 01/06/2017</p> <p>ERNESTINO BANDERA Administrador</p>	<p>DECLARAÇÃO DE CONFORMIDADE</p> <p>O abaixo-assinado, representando o seguinte construtor declara que o aparelho denominado</p> <p>START-S6XL BLOCK</p> <p>é conforme a todas as normas técnicas relativas ao produto dentro o campo de aplicabilidade das Diretivas Comunitarias 2006/42/CE, 2014/35/EU, 2014/30/EU e 2014/53/CE</p> <p>Foram executadas todas as necessárias provas de rádio frequência.</p> <p>EB TECHNOLOGY SRL Corso Sempione 172/5 21052 Busto Arsizio (Va) Italy</p> <p>Esta declaração vem emitida somente com a responsabilidade do construtor e, se aplicável, do seu representante autorizado.</p> <p>Busto Arsizio (Va) - Italia, 01/06/2017</p> <p>ERNESTINO BANDERA Administrador</p>

- Armoire monphasé pour 1/2 moteurs 230 Vac.
- Recepteur 433 Mhz intégré
- Apprentissage temps automatique

**Notice d'emploi
complète**

START-S6XL BLOCK

Récepteur Radio Intégré

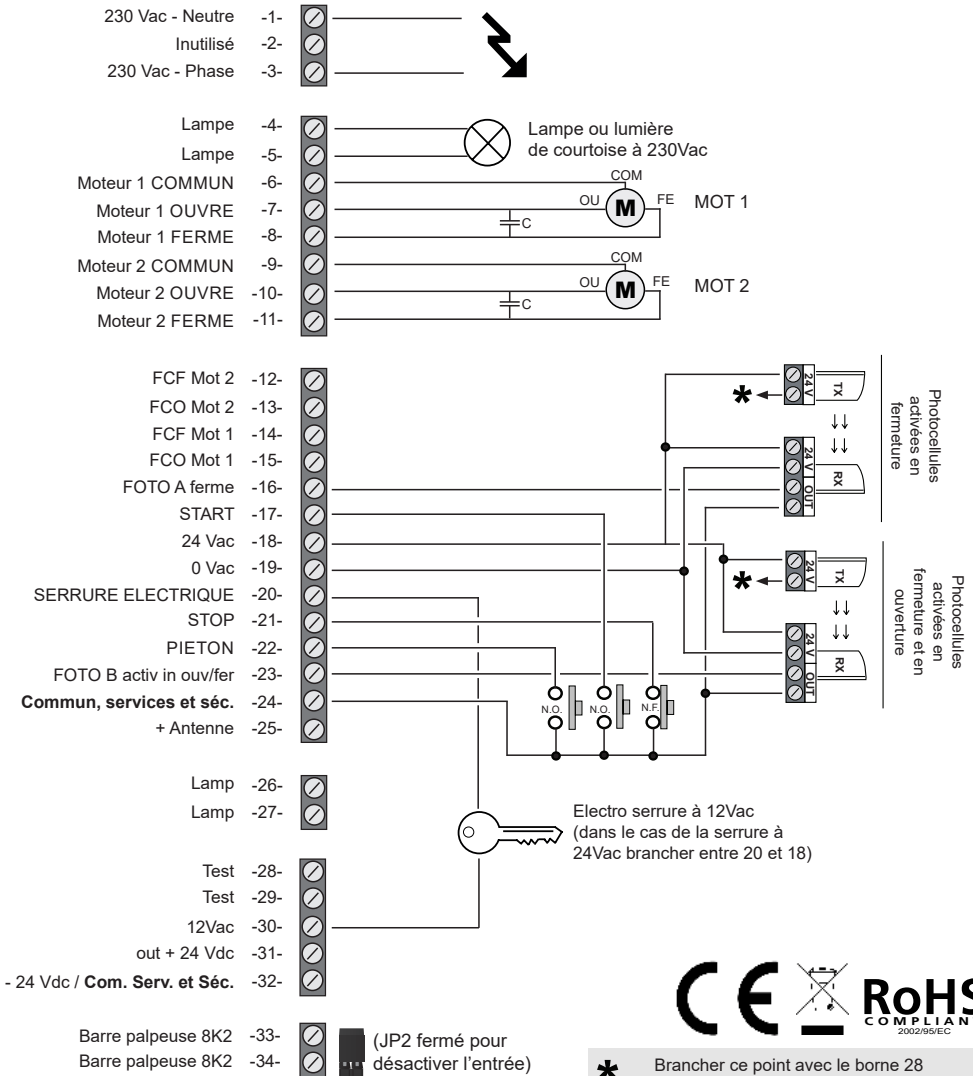

Introduction

Ce manuel donne tous les informations spécifiques nécessaires pour la connaissance et l'utilisation de l'armoire. Il faut le lire avec attention et le consulter afin qu'il n'y ait pas de souci sur son utilisation ou quand on prévoit de faire des consultations futures. Le fabricant se réserve le droit d'y apporter toutes les modifications jugées nécessaires sans préavis de sa part.

Sécurité et protection

Le fabricant n'est pas responsable pour des dommages dérivant d'une utilisation pas correcte ou une utilisation différente de la quelle le produit a été réalisé. Le fabricant n'est pas responsable pour des dommages conséquents à exception de la responsabilité civile sur les produits.

L'automatisme doit être réalisée selon les normes européenne: **EN 60204-1, EN 12445, EN 12453**. Il est obligatoire se tenir à les normes pour les fermeture véhiculaires automatisées: **EN 12453, EN 12445, EN 12978** et normes nationaux. Le réglage de la force du vantail doit être mesurée avec un appareil réglé selon la norme **EN 12453**.

Sécurité et protection du milieu

La directive européenne 2002/96/EC demande à ce que les platines ayant ce symbole sur le produit ou / et sur l'emballage ne doivent pas être jetées avec les ordures ménagères. Il est de la responsabilité du propriétaire de diriger les produits ou autres dispositifs électroniques vers des centres de traitement spécialisés pour ce type de déchet.



Le fabricant n'est pas responsable pour des dommages dérivant d'une utilisation incorrecte ou une utilisation différente pour laquelle le produit a été conçu.

Petit Légende

FCO	Fin de course ouvre
FCF	Fin de course ferme
START	Commande pour la marche du portail
PEDONALE	Coulissant: ouverture partielle
Vac	Alternate current
Vdc	Direct current
NF	Normalement ferme
NO	Normalement ouvre
Contact sec	Isolé des tension

Indice de chapitres



Par.	Description	Pag.
2	Description du produit	4
2.1	Caractéristiques	
2.2	Champs d'application	
2.3	Caractéristiques techniques	
3	Introduction	5
3.1	Contrôle préliminaires	
3.2	Type des câbles	
3.3	Notes sur les branchements	
4	Installation de l'armoire	6
4.1	Schéma de l'armoire et branchements électriques	
4.2	Branchement de la TENSION de RESEAU	7
4.3	Branchement du MOTEUR	
4.4	Branchement de la LAMPE	
4.5	Branchement d'un voyant 24Vdc	
4.6	Branchement de la LUMIÈRE	8
4.7	Branchement ANTENNE	
4.8	Branchement des dispositifs d'arrêt sur le STOP	
4.9	Branchement de fin de course FCO et FCF	
4.10	Branchement des commandes START et PIETON	9
4.11	Branchemen de la SERRURE 12 ou 24 Vac	
4.12	Alimentation des ACCESSOIRES	
4.13	Branchement des CELLULES A	10
4.14	Branchement des CELLULES A avec FOTOTEST	
4.15	Branchement des CELLULES B	11
4.16	Branchement des CELLULES B avec FOTOTEST	
4.17	Contrôll e des branchements	12
5	Fonctionnement et réglage	12
5.1	Programmation avec DIP B	
5.2	Programmation avec DIP A	14
5.3	Fonctionnement avancé	15
6	Gestion EMETTEURS	16
6.1	EFFACEMENT des codes en mémoire	
6.2	Activation du ROLLING CODE HCS	
6.3	MEMORISATION de la telecommande fonction	16
8	Effacement de la mémoire	
8	Apprentissage TEMPS	17
8.1	Mémorisation STANDARD	
8.2	Apprentissage TEMPS AVANCE	18
8.3	Apprentissage temps OU VERTURE PIETONNE	19
8.4	Apprentissage rapide TEMP DE PAUSE	20
9	Notice d'emploi pour l'utilisation du TEST	
10	Réglage TRIMMER	21
11	Note	
11	Déclaration de Conformité	23

1 Introduction

1.1 Précaution de sécurité

Le fabricant n'est pas responsable pour les dommages découlant d'une utilisation incorrecte ou une utilisation différente pour laquelle le produit a été conçu. Le fabricant n'est pas responsable des dommages occasionnés à l'exception de la responsabilité civile sur les produits. Toutes les installations de portails et portes automatiques doivent être installés par des professionnels qualifiés selon la norme.

1.2 Symboles et instructions

	<p><u>Danger</u></p> <p>Indique avertissement de sécurité et non observation provoque des dommages matériels!</p>		<p><u>Lire attentivement ce manuel</u></p> <p>Lire avec attention le manuel avant d'utiliser le produit et conserver le manuel pour usage futur.</p>
	<p><u>Dispositif sous tension</u></p> <p>Installation contrôlée par des professionnels qualifiés.</p>		

1.3 Système de sécurité

Il est important d'analyser les risques de la **MACHINE** et des requêtes du client pour établir le nombre des accessoires à installer. Dans le schéma les cellules **FOTO A** en ouverture n'ont aucun effet, elle provoque un inversion pendant la fermeture. La **FOTO A2** est le branchement en série de **FOTO A** ou le branchement de **ALT**. Contrôler que les cellules soient bien synchronisées et protégées contre les interférences.

Portails à battants

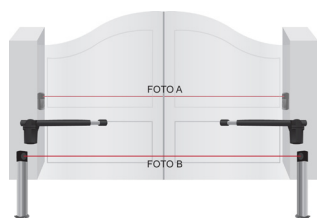

Portails coulissants

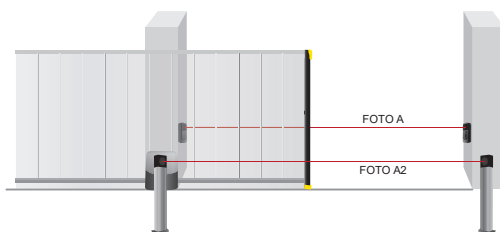

Il est conseillé d'installer un interrupteur STOP pour le blocage immédiat de la porte. L'interrupteur doit être à contact normalement fermé qui s'ouvre comme indiqué sur le Par. 4.8

2 Description du produit

START-S6XL BLOCK est une nouvelle armoire avec bornes à enlever. Elle est réalisée pour satisfaire beaucoup des exigences pour portails coulissants et battants. Dans le concept on a adoptées les techniques les plus innovantes pour garantir aucune interférence, la meilleure flexibilité d'utilisation et une grande plage de fonctionnalités disponibles.

2.1 Caractéristiques techniques

☞	Reglage vitesse de ralentissement
☞	Auto-apprentissage des temps de travaux
☞	Reglage électronique de la force du moteur
☞	4 modes de fonctionnement (compropiété inclus)
☞	Programmation avec dip-switch
☞	Contact "sec" pour voyant portail ouvert
☞	Recepteur intégrée pour la gestion des codes rolling
☞	Dimensions réduites
☞	Ouverture partielle avec commande séparée
☞	Serrure électrique avec coup de belier
☞	Exclusion des entrées de sécurité par microswitch
☞	Fonction TEST compatible avec TRANSCEIVER

2.2 Champs d'application

L'armoire électronique START-S6XL BLOCK est destinée pour portails coulissants, porte de garage, stores et portes automatiques. Elle peut commander un moteur oléodynamique ou électromécanique sous 230Vac.

2.3 Caractéristiques techniques

Dimensions	150 x 135 x 50	mm
Poids	500	g
Puissance MAXIMALE du moteur	1	HP
	750	W
	4	A
Puissance MAXIMALE de la lampe	40	W
Courant MAXIMAL du contact sec	2	A
Courant MAX 24 Vac (borne 18-19)	300	mA
Courant MAX 12 Vac (borne 19-30)	600	mA
Courant MAX 24 Vdc (borne 31-32)	100	mA

3 Introduction

3.1 Contrôle préliminaires

Il est important de choisir la bonne armoire pour une installation sûre et une bonne protection contre les agents atmosphériques. On rappelle que l'armoire contient des parties sous tension et des composants électroniques qui sont sensibles à l'humidité et aux infiltrations d'eau. L'armoire dispose d'un boîtier qui a un indice de protection IP55. Il faut installer l'armoire sur une surface insurmontable, plane et protégée contre les coups, à 40 cm du sol.

Avant de l'installer, vérifier la robustesse de la mécanique du portail ou de la porte, contrôler les butées mécaniques, quelles soient aptes pour arrêter en cas du panne de fin de course électriques ou de manoeuvre manuelle.

3.2 Type des câbles

Selon l'installation, faire attention au type et au nombre de dispositifs installés, les câbles peuvent différer. Dans le tableau il est indiqué le type de câble pour une installation standard.

Les câbles utilisés doivent être conforme à la norme EC 60335

⇒	Ligne électrique d'alimentation	Câble 3x1,5 mm ²
⇒	Câble du moteur (si n'est pas prévu)	Câble 4 x 1,5 mm ²
⇒	Lampe	Câble 2x1,5 mm ²
⇒	Antenna radio	Câble blindé comme RG58
⇒	Selecteur à clé	Câble 3x0,5 o 0,75 mm ²
⇒	Cellule Rx	Câble 4x0,5 o 0,75 mm ²
⇒	Cellule Tx	Câble 2x0,5 o 0,75 mm ²

3.3 Notes sur les branchements

Pour assurer la sécurité du professionnel et pour prévenir des dommages aux composants, lorsque l'on effectue les branchements ou on insère le récepteur radio, l'armoire ne doit pas être alimentée.









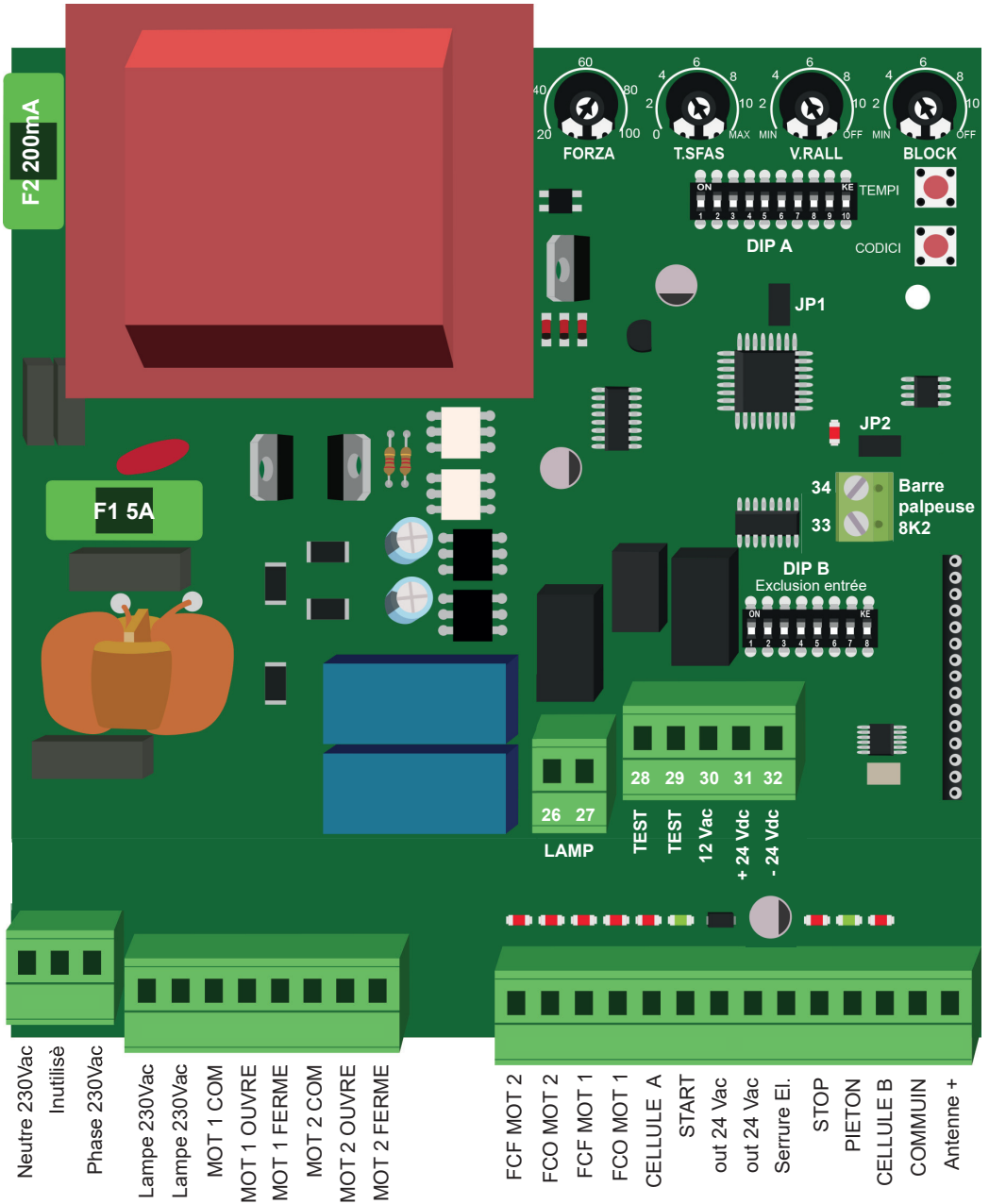























- Il faut alimenter l'armoire à travers un câble de 3x1,5mm². Si la distance entre l'armoire et le branchement est supérieure à 30mt il est nécessaire d'augmenter la section de la ligne.
- Si les moteurs sont prévus avec des câbles de 4x1,5 mm² (ouvre + ferme + commun + terre).
- Dans le cas de branchements en basse tension il faut utiliser des câbles de section de 0,5 ou 0,75mm².
- Il faut utiliser des câbles blindés si la longueur est supérieure à 30 mt et il faut brancher l'antenne à côté de l'armoire.
- Il faut éviter de faire des connections de câbles dans des caisses enterrées mêmes étamés.
- Pour les entrées des contacts normalements fermés, si non, faire un pont avec le commun.
- Si pour le même contact il y a plusieurs contacts il faut les brancher en série.
- Pour les entrées des contacts normalement ouvert, si non utilisées il faut les laisser libres.
- Si pour la même entrée il y a plusieurs contacts (N.O.) il faut les brancher en parallèle.
- Les contacts doivent être mécaniques.

On rappelle que tous les portails et portes doivent être installés par des professionnels qualifié selon la loi.

4 Installation de l'armoire

4.1 Schéma de l'armoire et branchements électriques



230 Vac Neutre	1		Alimentation électrique 230 Vac 50 Hz NEUTRE
<i>Inutilisé</i>	2		<i>Inutilisé</i>
230 Vac Phase	3		Alimentation électrique 230 Vac 50 Hz PHASE
Lampe	4		Sortie pour clignotant ou lampe de courtoise 230 Vac, max puissance de la lampe 40 ou 100W. LUMIERE de COURTOISE 230Vac,
	5		
M 1 Com	6		Sortie pour branchement moteur 1 pôle COMMUN
M 1 Ouvre	7		Sortie pour branchement moteur 1 pôle OUVERTURE
M 1 Ferme	8		Sortie pour branchement moteur 1 pôle FERMETURE
M 2 Com	9		Sortie pour branchement moteur 2 pôle COMMUN
M 2 Ouvre	10		Sortie pour branchement moteur 2 pôle OUVERTURE
M 2 Ferme	11		Sortie pour branchement moteur 2 pôle FERMETURE
FCC M2	12		Entrée fin de course Fermeture moteur 2
FCA M2	13		Entrée fin de course Ouverture moteur 2
FCC M1	14		Entrée fin de course Fermeture moteur 1
FCA M1	15		Entrée fin de course Ouverture moteur 1
Cellule A	16		Entrée cellule A seulement fermeture
START	17		Entrée commande bistable START
24Vac	18		Sortie 24Vac
24Vac	19		Sortie 24Vac
12Vac Serrure	20		Sortie serrure électrique 12Vac 50Hz 1A
STOP	21		Entrée STOP
PIETON	22		Entrée commande bistable ouverture partielle PIETONNE
Cellule B	23		Entrée cellule B activée en Fermeture et Ouverture
Commun 1 -	24		Commun pour toutes les entrées: services, sécurité, câble coaxial, antenne
Antenna +	25		Entrée pour l'antenne
lampe ou voyant	26		Contact pour Voyant (pour carte elec. sans clignote)
lampe ou voyant	27		Contact pour Voyant (pour carte elec. sans clignote)
Test	28		Sortie Test
Test	29		Sortie Test
12Vac Serrure	30		Sortie 12Vac
24Vdc +	31		Sortie 24Vdc +
Com. 24Vdc -	32		Sortie 24Vdc - Commun pour les entrées services et sécurité
Barre palpeuse 8K2	33		Barre palpeuse 8K2 (JP2 fermé pour désactiver l'entrée)
	34		

4.2 Branchement de la TENSION de Réseau

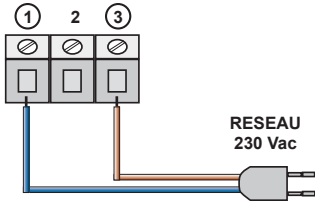

230 Vac. La ligne d'alimentation vers l'armoire doit être toujours protégée par un interrupteur électro-magnétique ou par un pareil de fuse 5A.

Un interrupteur différentiel est conseillé mais il n'est pas nécessaire si est déjà disponible sur l'installation.

4.3 Branchement du MOTEUR

Il faut faire attention pas invertire les pôles OUVRE et FERME. En cas de souci sur le branchement, il faut positionner manuellement le portail au demi de la course. Il faut se tenir prête pour arrêter l'installation sur STOP!

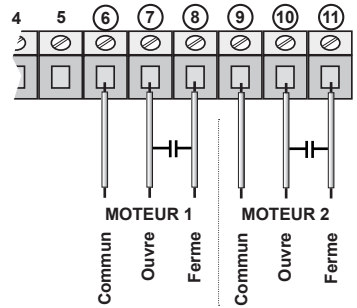

4.4 Branchement de la LAMPE

Lampe complet de clignotante

Lampe sans clignote

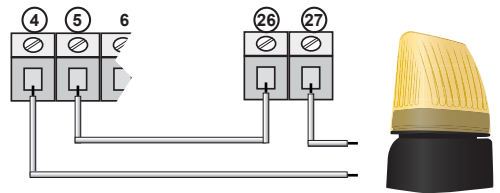
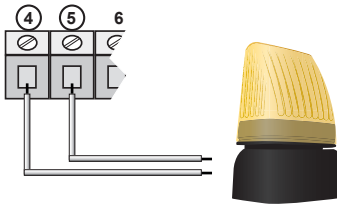

! Si on prévoit d'utiliser le test sur les cellules ou un voyant de 24V on en peut pas utiliser ce branchement.

4.5 Branchement d'un voyant 24Vdc portail ouvert et en marche

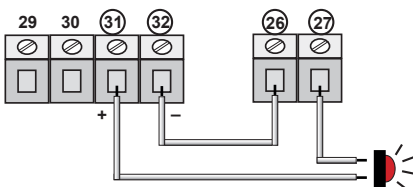

! Si on prévoit d'utiliser le test sur les cellules ou une lampe on ne peut pas utiliser ce branchement.

! Pour le voyant fixe ou clignotant il faut maintenir appuyé le touche TEMPI quand la porte ferme jusqu'à la lumière ne clignote pas.

4.6 Branchement Voyant

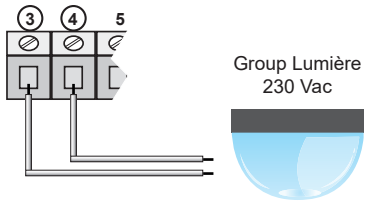

DIP 4 A - ON



4.7 Branchement ANTENNE

Si on utilise un câble pour l'antenne il faut le couper à 17 cm pour 433.92Mhz et le brancher sur le borne 25.

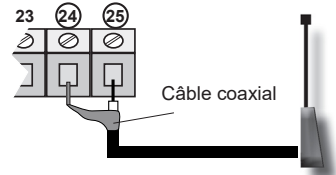

IL FAUT BRANCHER L'ANTENNE APRÈS LA MÉMORISATION DES ÉMETTEURS !!

4.8 Branchement des dispositifs d'arrêt sur le STOP

Branchement du commande **STOP**

Touche: arrête et interdit jusqu'à une nouvelle commande.
Interrupteur: Le portail est bloqué jusqu'à le rétablissement du même interrupteur

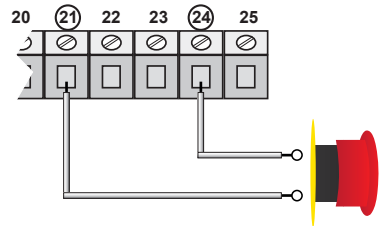

! Si l'entrée **STOP**
N'EST pas utilisé poner en ON le DIP 6 C

Le branchement des dispositifs prévoit l'utilisation de n'importe quel touche ou contact N.C. (normalement fermé). Plusieurs dispositifs ils faut les brancher en serie

4.9 Branchement de fin de course FCO (ouvre) et FCF (ferme)

Ils sont montré les deux fin de course:

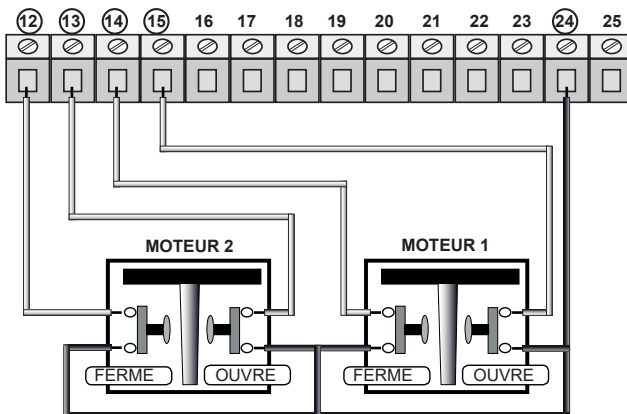

! Si les entrées **FCA** ou **FCF**
ne sont pas utilisé
il faut suivre le par. 5.1

Les contacts doivent être (normalement fermé)

4.10 Branchement des commandes "START" et "PIETON"

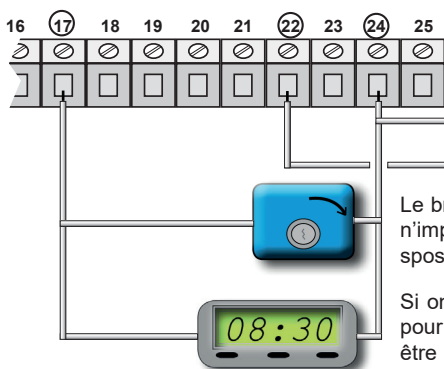

Le branchement de la commande ouvre piéton peut être branché dans n'importe quel touche ou contact normalement ouvert.

Le branchement de la commande ouvre START peut être fait dans n'importe quel touche ou contact normalement ouvert. Plusieurs dispositifs sont branché en serie.

Si on utilise les bornes 17 et 24 est possible brancher un horloge pour programmer l'ouverture du portail. Le contact de l'horloge doit être normalement ouvert et doit rester fermé pour le temps que le portail reste ouvert. Si il y a un branchement sur l'ouverture 17, il faut le brancher en serie.

4.11 Branchement de la SERRURE

Ici le branchement de la serrure électrique de **12 Vac**:

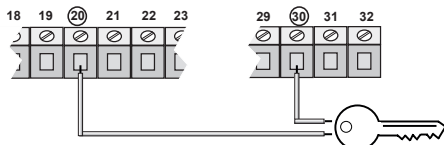

Ici le branchement de la serrure électrique de **24 Vac**:

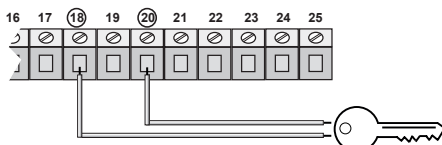

4.12 Alimentation des ACCESSOIRES

Ici le branchement de l'alimentation des accessoires, la tension du reseau est 12 Vac disponible sur les bornes 19-30.

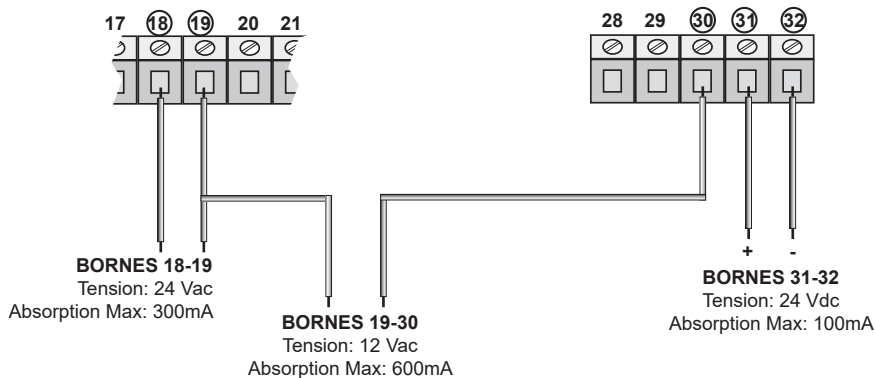

4.13 Branchement des CELLULES A (seulement ferme) 24 Vac

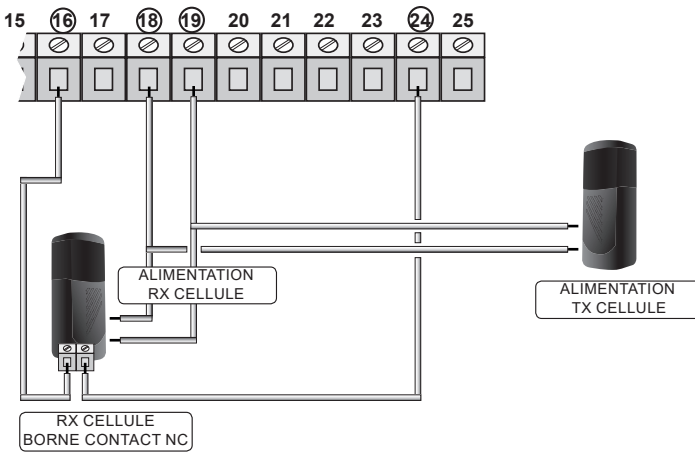

Le contact du récepteur doit être:

- **sec** (isolé des tensions d'alimentation)
- **tipo N.C.** (normalement fermé)

Pour plusieurs cellules il faut les brancher en série.

! Si l'entrée FOTO A n'est pas utilisée, mettre ON le DIP 5 B

4.14 Branchement des CELLULES A avec FOTOTEST 24 Vac

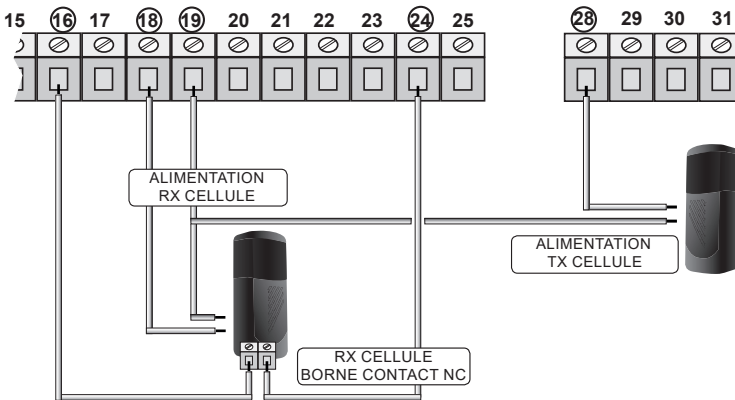

Le contact du récepteur doit être:

- **sec** (isolé des tensions d'alimentation)
- **tipo N.C.** (normalement fermé)

Pour plusieurs cellules il faut les brancher en série.

Le TEST sur cellule assure le fonctionnement régulier de l'automatisme. L'armoire fait un test au début avant l'ouverture. En cas de mauvais fonctionnement des cellules, la lampe s'allume pendant 5 secondes mais le portail ne marche pas.

Pour activer le fonctionnement TEST lire et suivre avec attention le chapitre 9

4.15 Branchement des CELLULES B (ouvre et ferme) 24 Vac

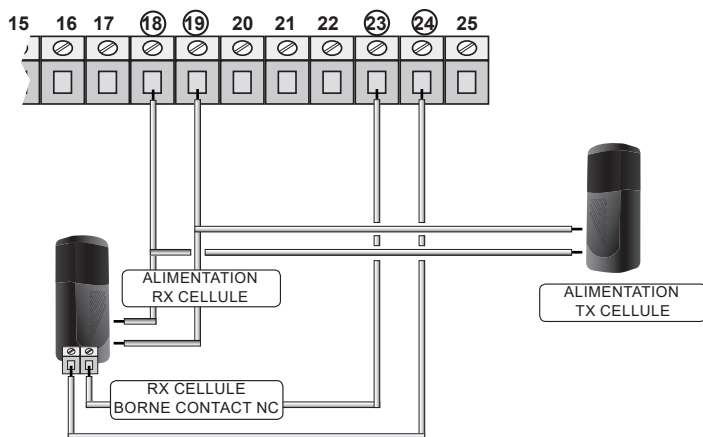

Le contact du recepteur doit être:

- **sec** (isolé des tension d'alimentation)
- **tipo N.C.** (normalement fermé)

Pour plusieurs cellules il faut les brancher en serie.

! Si l'entrée FOTO A n'est pas utilisé poner ON le DIP 6 B

4.16 Branchement des CELLULE B avec FOTOTEST 24 Vac

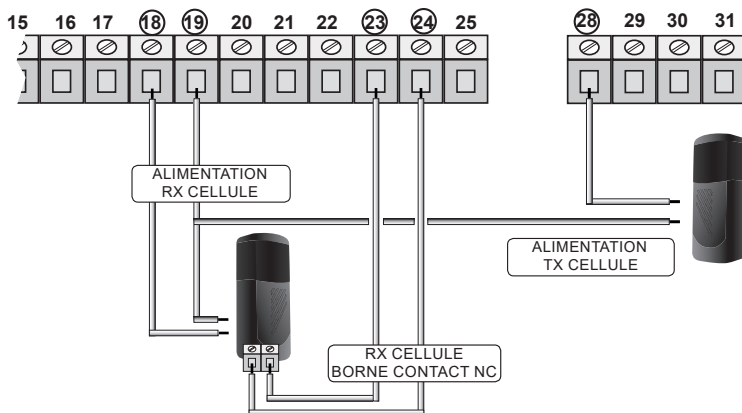

Le contact du recepteur doit être:

- **sec** (isolé des tension d'alimentation)
- **tipo N.C.** (normalement fermé)

Pour plusieurs cellules il faut les brancher en serie.

4.17 Contrôle des branchements

Quand l'armoire est alimenté, les voyants "led", sur les entrées, sont allumées quand le contact est fermé sur le commun.

Normalement les voyants rouges sur les entrées **FCF - FCO - STOP- FOTO** sont toujours allumées

Normalement les voyants verts sur les entrées **START - PIETONNE** sont éteintes

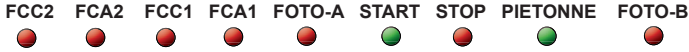

Si pendant le clignote du **LED L1**, le voyant n'éteint pas complètement, ça signifie que l'entrée **BARRE PALPEUSE 8k2** est en pause ou interdit

VISUALISATION de l'état du portail:

- LED L1**
- 1 clignote indique le normal fonctionnement
 - 2 clignotes indique l'activation du rolling code complet
 - Pas de clignote indique que JP1 est fermé et on est sur le fonctionnement avancé.





5 Fonctionnement et réglage









L'armoire dispose des micro-interrupteurs qui permettent d'activer les fonctionnements plus indiqués à l'installation.

5.1 Programmation avec DIP B

	1-ON	FCF M2 12	Exclusion entrée fin de course ferme moteur 2
	2-ON	FCO M2 13	Exclusion entrée fin de course ouvre moteur 2
	3-ON	FCF M1 14	Exclusion entrée fin de course ferme moteur 1
	4-ON	FCO M1 15	Exclusion entrée fin de course ouvre moteur 1
	5-ON	Cellule A 16	Exclusion entrée photocellule en fermeture
	6-ON	Cellule B 23	Exclusion entrée photocellule toujours activée
	7-ON	STOP 21	Exclusion entrée stop
	8-ON	Recepteur Intégré	Fonction recepteur intégré







5.2 Programmation avec DIP A

	1-OFF 2-OFF	Automatique 1	Chaque commande renverse: ouvre - ferme. <i>Referme automatiquement après le temp de pause</i>
	1-ON 2-OFF	Comproprété	En fermeture et pause n'accepte aucun commande. Referme automatiquement après le temp de pause
	1-OFF 2-ON	Semi automatique	Par chaque logique ouvre-stop-ferme-stop-ouvre etc... <i>Il ne referme pas automatiquement</i>
	1-ON 2-ON	Automatique 2	Chaque commande suit la logique: ouvre-stop-ferme-stop-ouvre etc... <i>Referme automatique après le temp de pause</i>

	3-ON	Coup de belier	Cet programmation permet d'activer une impulsion en fermeture au debut et à la fin de la manoeuvre pour faciliter le fonctionnement de la serrure électrique.
	4-ON	Lumière de courtoise	Sur la sortie des bornes 4 et 5 il y en a la tension du debut de l'ouverture jusqu'à deux minutes après la fermeture, c'est utile pour alimenter la lumière de courtoise.
	5-ON	Pre-clignote	Il faut activer le pre-clignote avant le debut de la moeuvre.
	6-ON	Relève le passage	Quand les cellules on marqué le passage, l'armoire complète l'ouverture et après il diminue le temp de pause à 1 seconds o.
	7-ON	Lampe en pause	La lampe reste activé dans le temp de pause.
	8-ON	Phototest	Activation du photo-test (avec TRANSCIEVER voir Chap.9)
	9-ON	Déphasage ouverture	En ON le temp de déphasage est à 2 seconds. Le temp de déphasage en fermeture est cel programmé avec le trimmer "Déphasage".
	10-ON	Temps avancé	Activation de la fonction d'apprentissage temps de travail avancé

5.3 Fonctionnement avancé

Pour accéder au fonctionnement avancé, il faut suivre les passages suivants



	1	Il faut s'assurer que le portail est fermé et que le JUMPER JP1 soit fermé
	2	LED L1 arrête le clignote, à chaque pression les touches TEMPI (temps) et LED L1 clignote pour indiquer le fonctionnement choisi.
1 clignote	1 moteur	Activation fonctionnement un moteur. L'armoire fait toutes les manoeuvres pour moteur 1 et moteur 2. L'apprentissage des temps de travail est seulement pour le moteur 1.
2 clignotes	Homme Mort	Fonctionnement HOMME MORT, la commande START ouvre le commande PIETON ferme. Les moteurs s'arrêtent quand on relâche la commande.
3 clignotes	Industriel	La commande PIETON devient ferme quand la commande START suit la logique des dip 1 et 2.
4 clignotes	Depart gradué contrôlé	Les moteurs partent avec des niveaux minimum jusqu'à les valeurs programmés. Ce fonctionnement n'est pas compatible avec tous les portails.
 LED L1 - éteint fonctionnement OFF  LED L1 - allumé fonctionnement ON	3	Après que LED L1 clignote (selon le fonctionnement choisi) LED reste éteint pour le fonctionnement choisi (OFF) et reste allumé pour la programmation en ON .
	4	Pour changer de OFF à ON il faut appuyer et relâcher le touche CODICI (CODES)
	5	Pour retourner au fonctionnement STANDARD , le JUMPER JP1 soit OUVERT

6 Gestion DES TELECOMMANDES

La carte électronique peut gérer plusieurs type de codes. Le premier émetteur mémorisé indiquera le type de code à gérer. on peut gérer des codes de 12 et 14 bits et pour le Rolling code HCS on peut gérer seulement la partie fixe du code (sauf TX BANDY). Pour activer le Rolling code il faut activer le dip 12 (n°3 du dip B). Les émetteurs Rolling code ne peuvent pas être copiés. Il est possible de mémoriser 200 télécommandes Rolling code réf BANDY. ATTENTION: Le récepteur radio intégré de cette centrale peut mémoriser seulement 1 code. Avant de commencer à programmer les télécommandes il est IMPERATIF d'effacer tous les codes qui ont été intégré dans le récepteur lors des tests en usine (voir 6.2)

6.1 EFFACEMENT DES CODES EN MEMOIRE

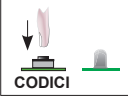
Cette opération est possible quand tous les codes sont déjà mémorisés. on ne peut pas effacer un seul code mémorisé. Il faut effacer la mémoire avant de mémoriser le premier émetteur ansi d'éviter d'utiliser des codes qui ne sont pas utilisés L'effacement de la mémoire est possible seulement lorsque le portail est fermé.

	1	Il faut s'assurer que le portail soit FERME Tenir appuyé pendant 10 sec. Minimum sur le bouton CODES (CODICI)
	2	Attendre que le LED CODICI clignote et après il faut relâcher. Attendre l'effacement de la mémoire.

6.2 Activation du ROLLING CODE HCS

PROGRAMMATION CODES FIXE (L1 - un clignote)

Les codes en gestion sont standard de 12 à 64 bit et pour le codes rolling HCS on peut enregistrer la partie fixe

PROGRAMMATION ROLLING COMPLETE (L1 - 2 clignotes)

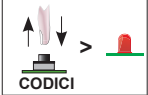
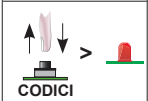
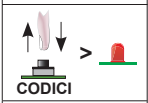

On contrôle le rolling code, les émetteurs ne peuvent pas être copiés



	1	Appuyer et relâcher le touche CODICI (CODE) , LED L1 reste allumé fixe.
	2	Appuyer encore le touche CODICI et LED L1 clignote et reste allumé
	3	Appuyer encore le touche CODICI et LED L1 clignote 2 fois activation rolling code.
	4	Pour retourner à la programmation fixe, repeter au point 1, dans cette manière LED L1 clignote 1 fois.

6.3 MEMORISATION DE LA TELECOMMANDE FONCTION

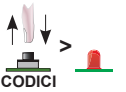
(écrire en plus gros) La mémorisation des émetteurs est possible **EXCLUSIVEMENT** portail fermé.

IL FAUT MEMORISER LES CODES SANS BRANCHER L'ANTENNE AUX BORNES 24-25

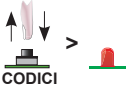
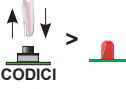
	1	S'assurer que le portail soit FERME
	2	Appuyer et relâcher le touche CODICI , le LED CODICI reste allumé fixe.
	3	Appuyer le touche de l'émetteur par exemple: 1°, si est appris le LED CODICI clignote.

	1	Appuyer 1 fois sur le bouton CODES (CODICI) le Led s'éclaire fixe
	2	Appuyer immédiatement une autre fois sur le bouton CODES (CODICI) le LED clignote 2 fois puis s'éclaire fixe
	3	Appuyer immédiatement sur le bouton n°2 de l'émetteur le Led clignote rapidement pour indiquer que le récepteur a mémorisé le 2ème bouton, attendre que le Led CODES (CODICI) se mette à clignoter régulièrement. (dans le dessin veuillez remplacer PEDONALE par PIETON)

- Si on mémorise un nouveau émetteur, il faut répéter l'opération.

- Si quand on appuie le LED CODICI la lumière reste allumé, ça signifi e que l'émetteur n'est pas COMPATIBLE.

- Si quand on appuie le touche de l'émetteur, LED CODICI clignote lentement ça signifi que la mémoire code est pleine.

- On ne peut pas effacer un seul code de l'émetteur.







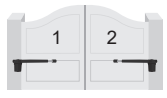

7 Effacement de la mémoire

L'effacement de la mémoire re-programme les temps de fonctionnement standard de l'armoire. L'effacement de la mémoire temps de travail n'efface pas les codes des émetteurs mémorisés, ils sont deux mémoires différents.

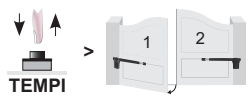
	1	Appuyer les touches CODICI et TEMPI Les LED L1 s'allument
	2	Attendre 10 seconds, jusqu'à les voyants L1 s'éteignent
	3	Relâcher les touches CODICI et TEMPI

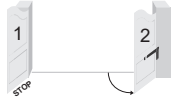
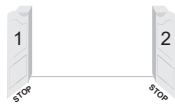

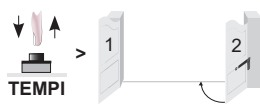
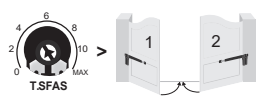
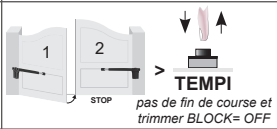

8 Apprentissage TEMPS

8.1 Mémorisation STANDARD

1		L'automatisme est FERME
2		Poner en OFF l'interrupteur 10 du DIP A
3		* Appuyer le touche TEMPI (temp) Le 1er moteur part
4		Après le déphasage automatiquement (T.SFAS), le 2em moteur ouvre
5		Attendre que le premier vantail ouvre complètement , si il y a le fin e course lire au point no.6 si non appuyer le touche TEMPI pour arrêter le premier vantail.
6		Moteur n°1 arrête, attendre que même le moteur n°2 arrête
7		Quand les deux moteurs s'arrêtent , laisser passer les temps pour le quel le portail reste ouvert (temp de pause)
8		Appuyer le touche TEMPI pour commencer la fermeture, le deuxiem vantail ferme.
9		Après le déphasage automatiquement (T.SFAS) le 1er moteur FERME
10		Attendre que le deuxiem vantail ferme complètement, appuyer le touche TEMPI SEULEMENT DANS LE CAS que le fin de course ne sont pas montés et le trimmer BLOCK est installé sur OFF : Attendre que le BLOCK soit programmé en OFF.
11		Attendre que le portail s'arrête complètement, c'est la confirmation du correct apprentissage des TEMPS (fonction normal)

* Après la première pression du bouton TEMP on peut utiliser même la commande START du borne 17 ou par un touche de l'émetteur mémorisé.

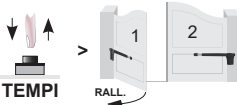
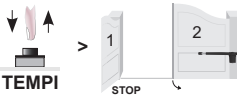
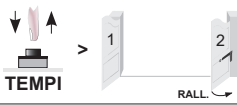
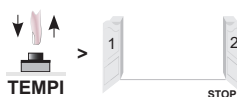

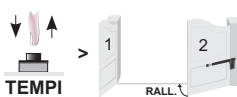
8.2 Le portail est FERME

		Le portail est FERME	
1		Poner et relâcher en ON le dip 10 A	Le portail est FERME
2		* Appuyer le touche TEMPI	Le 1er moteur OUVRE
3		Appuyer le touche TEMPO (ou START) ... si le ralentissements sont activés (trimmer V.RALL) ...	Le 1er moteur ralenti en ouverture
4		Appuyer le touche TEMPI (ou START), si il n'y a pas le fin de course ouvre du 1er moteur.	Le 1er moteur s'arrête, art le 2em moteur
4 a		... si il y a le fin de course attendre que l'arrête du premier moteur	Le 1er moteur s'arrête, départ le 2em moteur OUVRE
5		Appuyer le touche TEMPI (ou START)... si les ralentissement sont activés (trimmer V.RALL)	Le 2em moteur ralenti en ouverture
6		Appuyer le touche TEMPI (ou START) (si il n'y a pas le fin de course ouvre 2°)	Le 2em Moteur s'arrête, part le comptage du temp de pause
6 a		...si il y la fin de course attendre que le moteur 2 s'arrête	Le 2em Moteur s'arrête, part le comptage du temp de pause
		Laisser passer le temp de pause	
7		Appuyer le touche TEMPI (ou START)	Le 2em moteur FERME
8		Appuyer le touche TEMPI (ou START) ... si le ralentissements sont activés (trimmer V.RALL)...	Le 2em moteur ralenti en fermeture

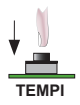
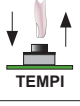

9		Appuyer le touche TEMPI (ou START) (si il n'y a pas le fin de course ferme)	Le 2em moteur ferme, s'arrête, déaprt le moteur 1 en FERME
9 a		... si il y a le fin de course attendre l'arrête du 2em Moteur	Le 2em Moteur s'arrête, départ Le moteur n° 1° en FERME
10		Appuyer le touche TEMPI (ou START) Si le ralentissement sont actives (trimmer V.RALL)...	Le moteur n1° ralnet en fermeture
11		Appuyer le touche TEMPI (ou START) (si le fin de course n'est pas disponible 1°)	Le 1er Moteur s'arrête. APPRENTISSAGE TERMINÉ
11 a		... si il y a le fin de course il faut attendre le 1er moteur	Le 1er moteur s'arrête Apprentissage terminé

* Après la première pression du bouton TEMP on peut utiliser même la commande START du borne 17 ou par un touche de l'émetteur mémorisé.

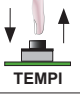
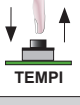
8.3 Apprentissage temps OUVERTURE PIETONNE

Le portail est FERMÉ			
	1	Appuyer et maintenir appuyé le touche TEMPI jusqu'à le 1er moteur OUVRE, après il faut relâcher le touche TEMPI	1er moteur OUVRE
	2	Appuyer le touche TEMPI	Le 1er moteur s'arrête
		Laisser passer le temp de PAUSE pour l'ouverture pietonne	
	3	Appuyer le touche TEMPI	Le 1er moteur FERME
	4	Appuyer le touche TEMPI (si le fin de course n°1 n'est pas disponible)	Le moteur 1 s'arrête. La porte piétonne est fermée. TERMINÉ
	4 a	... si le fin de course est disponible attendre que le moteur n°1 s'arrête (PIETON) en fermeture	Le moteur 1 s'arrête au fin de course ferme. La porte piétonne est fermée. TERMINÉ

8.4 Apprentissage rapide TEMP DE PAUSE





Le portail est en PAUSE			
	1	Appuyer et relâcher le touche TEMPI	Le voyant OUVRE et ferme reste allumé
		Laisser passer le temp de PAUSE désiré	
	2	Appuyer et relâcher le touche TEMPI	Le portail FERME Apprentissage terminé

9 Notice d'emploi pour l'utilisation du TEST

Le fonctionnement TEST est compatible avec les appareils avec un temp de reponse plu lent (par exampe RADIOBAND), si les dispositifs sont installés, l'ouverture est retardée de quelque instant. on peu tester plusieurs dispositifs branché sur l'entrée STOP.

Afin que l'armoire releve les dispositifs branchés sur les entrées (Foto- cellula B) et STOP sont en TEST il faut suivre la procédure suivante:

Brancher le TEST comme suivant:

	1	L'armoire est éteindue: poner OFF le dip 8 du DIP A
	2	Donner alimentation à l'armoire et attendre que le led clignote regulièrement
	3	Poner en ON le dip 8 du DIP A
	4	Il faut ouvrir le portail avec la commande START ou l'apprentissage des temps si nécessaire o (Par. 5.1)

**Il'armoire relève les dispositifs sous TEST
et pour cette raison le départ est retardée de quelque instant**

12 Déclaration de Conformité

(selon la directive 2006/42/CE, Attachée II, partie B)

Le sous-signé Ernestino Bandera
Administrateur

Déclare que:



Société: EB TECHNOLOGY SRL
Adresse: Corso Sempione 172/5
 21052 Busto Arsizio VA Italy
Nom du produit: START-S6XL BLOCK
 Armoire monophasé
 pour 1/2 moteurs 230 Vac

LE PRODUIT EST CONFORME

selon la directive communautaire:

2006/42/CE

DIRECTIVE 2006/42/CE DU PARLEMENT EUROPEEN DU CONSEIL du 17 mai 2006 concernant le rapprochement des lois des Etats membres concernant les machines.

Référence Attachée II, partie B (déclaration CE de conformité du fabricant).

LE PRODUIT EST CONFORME**Selon la directive communautaire, ainsi comme changée de la directive 93/68/CEE du conseil du 14 octobre 2004:****2014/35/CE**

DIRECTIVE 2014/35/UE DU PARLEMENT EUROPEEN ET DU CONSEIL du 26 février 2014 relative à l'harmonisation des législations des États membres concernant la mise à disposition sur le marché du matériel électrique destiné à être employé dans certaines limites de tension.

Référence aux normes harmonisées: EN 60335-1

2014/30/EU

DIRECTIVE 2014/30/UE DU PARLEMENT EUROPEEN ET DU CONSEIL du 26 février 2014 relative à l'harmonisation des législations des États membres concernant la compatibilité électromagnétique.

Référence aux normes harmonisées: EN 61000-6-2 EN 61000-6-3

LE PRODUIT EST CONFORME**Aux requêtes essentielles de l'article 3 de la norme suivante pour l'utilisation pour laquelle sont destinés:****2014/53/CE (RED)**

DIRECTIVE 2014/53/UE DU PARLEMENT EUROPEEN ET DU CONSEIL du 16 avril 2014 relative à l'harmonisation des législations des États membres concernant la mise à disposition sur le marché d'équipements radioélectriques et abrogeant la directive 1999/5/CE.

Références aux normes: ETSI EN 300 220-3 ETSI EN 301 489-1 ETSI EN 301 498-3

Comme indiqué de la directive 2006/42/CE on rappelle qui n'est pas admit le mis en service du produit jusqu'à la machine, dans le quel le produit est intégré, n'est pas identifié et conforme à la directive européenne 2006/42/CEDairago, 01/06/2017
Administrateur
Ernestino BanderaEB TECHNOLOGY S.r.l.
Corso Sempione 172/5,
21052 Busto Arsizio VA ItalyNOLOGO S.r.l.
via Cesare Cantù 26,
20020 Villa Cortese MI Italy
tel. +39 0331.430457
fax. +39 0331.432496posta@ebtechnology.it
www.ebtechnology.itinfo@nologo.info
www.nologo.info

<p>DICHIARAZIONE DI CONFORMITA'</p> <p>Il sottoscritto, rappresentante il seguente costruttore, dichiara che l'apparecchio denominato</p> <p>START-S6XL BLOCK</p> <p>risulta conforme a tutte le norme tecniche relative al prodotto entro il campo di applicabilità delle Direttive Comunitarie 2006/42/CE, 2014/35/CE, 2014/30/EU e 2014/53/CE</p> <p>Sono state eseguite tutte le necessarie prove di radiofrequenza</p> <p>EB TECHNOLOGY SRL Corso Sempione 172/5 21052 Busto Arsizio (Va) Italia</p> <p>Questa dichiarazione viene emessa sotto la sola responsabilità del costruttore e, se applicabile, del suo rappresentante autorizzato.</p> <p>Busto Arsizio (Va) - Italia, 01/06/2017</p> <p>ERNESTINO BANDERA Amministratore</p>	<p>DECLARATION OF CONFORMITY</p> <p>The undersigned, representative of the following manufacturer, hereby certifies that the equipment known as</p> <p>START-S6XL BLOCK</p> <p>complies with all technical requirements concerning this product within the domain of application of the EC Directives 2006/42/CE, 2014/35/CE, 2014/30/EU and 2014/53/CE</p> <p>All necessary radiofrequency tests have been performed</p> <p>EB TECHNOLOGY SRL Corso Sempione 172/5 21052 Busto Arsizio (Va) Italy</p> <p>This declaration is rendered under the manufacturer's sole responsibility, and if applicable, under responsibility of his authorized representative.</p> <p>Busto Arsizio (Va) - Italia, 01/06/2017</p> <p>ERNESTINO BANDERA Administrator</p>	<p>DÉCLARATION DE CONFORMITÉ</p> <p>Le soussigné, représentant du constructeur suivant certifie que les appareils ci-dessus référencés</p> <p>START-S6XL BLOCK</p> <p>sont conformes à toutes les normes techniques relativement au produit dans le domaine d'application des Directives Européennes 2006/42/CE, 2014/35/CE, 2014/30/EU et 2014/53/CE</p> <p>Toutes les essais de radiofréquence nécessaires ont été effectués</p> <p>EB TECHNOLOGY SRL Corso Sempione 172/5 21052 Busto Arsizio (Va) Italy</p> <p>Cette déclaration est présentée sous la seule responsabilité du constructeur et, si applicable, de son représentant autorisé.</p> <p>Busto Arsizio (Va) - Italia, 01/06/2017</p> <p>ERNESTINO BANDERA Administrateur</p>
<p>KONFORMITÄT SZERTIFIKAT</p> <p>Der Unterzeichner bescheinigt, dass das Produkt</p> <p>START-S6XL BLOCK</p> <p>allen technischen Produktegesetzen, laut den Europäischen Gesetzen 2006/42/CE, 2014/35/CE, 2014/30/EU e 2014/53/CE, entspricht.</p> <p>Alle Radiofrequenzprüfungen haben bei der nachstehenden Firma stattgefunden:</p> <p>EB TECHNOLOGY SRL Corso Sempione 172/5 21052 Busto Arsizio (Va) Italy</p> <p>Diese Bescheinigung wird unter der alleinigen Verantwortung des Herstellers ausgestellt und dort wohnbar, auch unter der des befugten Vertreters.</p> <p>Busto Arsizio (Va) - Italia, 01/06/2017</p> <p>ERNESTINO BANDERA Verwalter</p>	<p>DECLARACIÓN DE CONFORMIDAD</p> <p>El abajo firmante, representante el fabricante siguiente, declara que el equipo denominado</p> <p>START-S6XL BLOCK</p> <p>es conforme con todas las normas técnicas correspondientes al producto en el campo de aplicación de las Directivas Comunitarias 2006/42/CE, 2014/35/CE, 2014/30/EU y 2014/53/CE</p> <p>Han sido realizadas todas las necesarias pruebas de radiofrecuencia.</p> <p>EB TECHNOLOGY SRL Corso Sempione 172/5 21052 Busto Arsizio (Va) Italy</p> <p>Esta declaración se expide bajo la exclusiva responsabilidad del fabricante y, si de aplicación, de su representante autorizado.</p> <p>Busto Arsizio (Va) - Italia, 01/06/2017</p> <p>ERNESTINO BANDERA Administrador</p>	<p>DECLARAÇÃO DE CONFORMIDADE</p> <p>O abaixo-assinado, representando o seguinte construtor declara que o aparelho denominado</p> <p>START-S6XL BLOCK</p> <p>é conforme a todas as normas técnicas relativas ao produto dentro o campo de aplicabilidade das Diretivas Comunitarias 2006/42/CE, 2014/35/CE, 2014/30/EU e 2014/53/CE</p> <p>Foram executadas todas as necessárias provas de rádio frequência.</p> <p>EB TECHNOLOGY SRL Corso Sempione 172/5 21052 Busto Arsizio (Va) Italy</p> <p>Esta declaração vem emitida somente com a responsabilidade do construtor e, se aplicável, do seu representante autorizado.</p> <p>Busto Arsizio (Va) - Italia, 01/06/2017</p> <p>ERNESTINO BANDERA Administrador</p>